

PHILIPPINE BIDDING DOCUMENTS

Government of the
Republic of the Philippines

Procurement of **INFRASTRUCTURE PROJECTS**

First Edition
May 2025

Preface

These Philippine Bidding Documents (PBD) for the procurement of Infrastructure Projects (hereinafter referred to also as the “Works”) through [*Competitive Bidding, Limited Source Bidding, or Competitive Dialogue*¹] have been prepared by the Government of the Philippines (GoP) for use by all branches, agencies, departments, bureaus, offices, or instrumentalities of the Government, including government-owned and/or -controlled corporations (GOCC), government financial institutions (GFI), state universities and colleges (SUC), local government units (LGU), and autonomous regional government. The procedures and practices presented in this document have been developed through broad experience, and are for mandatory² use in projects that are financed in whole or in part by the GoP or any foreign government/foreign or international financing institution in accordance with the provisions of the Implementing Rules and Regulations (IRR) of Republic Act No. 12009 (RA No. 12009).

This PBD is intended as a model for admeasurements (unit prices or unit rates in a bill of quantities) types of contract, which are the most common in Works contracting.

The Bidding Documents shall clearly and adequately define, among others: (a) the objectives, scope, and expected outputs and/or results of the proposed contract; (b) the eligibility requirements of Bidders; (c) the expected contract duration; and (d) the obligations, duties, and/or functions of the winning bidder.

In order to simplify the preparation of the Bidding Documents for each procurement, the PBD groups the provisions that are intended to be used unchanged in Section II. Instructions to Bidders (ITB) and in Section IV. General Conditions of Contract (GCC). Data and provisions specific to each procurement and contract should be included in Section III. Bid Data Sheet (BDS); Section V. Special Conditions of Contract (SCC); Section VI. Specifications; Section VII. Drawings; and Section VIII. Bill of Quantities. The forms to be used are provided in Section IX. Philippine Bidding Documents Related Forms.

Prudence must be exercised to check the relevance of the provisions of the PBD against the requirements of the specific Works to be procured. In addition, each Section is prepared with notes intended only as information for the Procuring Entity or the person drafting the Bidding Documents. They shall not be included in the final documents, except for the notes introducing Section IX. Philippine Bidding Documents Related Forms, where the information is useful for the Bidder. The following general directions should be observed when using the documents:

- a) All the documents listed in the Table of Contents are normally required for the procurement of Infrastructure Projects. However, they should be adapted as necessary to the circumstances of the particular Project.
- b) Specific details, such as the “name of the Procuring Entity” and “address for proposal submission,” should be furnished in the BDS and SCC. The final documents should contain neither blank spaces nor options.
- c) This Preface and the footnotes, or notes in italics included in the Invitation to Bid, BDS, SCC, Specifications, Drawings, and Bill of Quantities are not part of the text of the final document, although they contain instructions that the Procuring Entity should

¹ For Second Stage of Competitive Dialogue under Section 29.4.2 of IRR of RA No. 12009.

² Unless the Treaty or International or Executive Agreement expressly provides use of foreign government/foreign or international financing institution procurement guidelines.

strictly follow. The Bidding Documents should not contain footnotes except Section IX. Philippine Bidding Documents Related Forms since these provide important guidance to Bidders.

- d) The cover page should be modified as required to identify the Bidding Documents and date of issue.
- e) The Project title page should be modified as required to identify the Project title and number, name and address of the Procuring Entity.
- f) If modifications must be made to the bidding requirements, they can be presented in the BDS. Modifications for specific Project or Contract details should be provided in the SCC as amendments to the Conditions of Contract. For easy completion, whenever reference has to be made to specific clauses in the BDS or SCC, these terms shall be printed in bold type face on Section II. Instructions to Bidders, and Section IV. General Conditions of Contract, respectively. To facilitate easy reference and completion, clauses from the BDS and SCC shall appear in bold type face in Sections II and IV, respectively.



**PROVINCIAL GOVERNMENT OF CAMARINES NORTE
DAET CAMARINES NORTE**

**Procurement of
INFRASTRUCTURE PROJECTS:**

**EXTENSION OF COVERED
COURT AND FLOORING**

P-4, Brgy. Mampurog, San Lorenzo Ruiz,

Camarines Norte

ITB-2026-032

January 27, 2026

TABLE OF CONTENTS

Glossary of Acronyms, Terms, and Abbreviations.....	6
Definition of Terms.....	8
Section I. Invitation to Bid	11
Section II. Instructions to Bidders	12
A. General	17
B. Contents of Bidding Documents.....	24
C. Preparation of Bids	25
D. Submission and Opening of Bids	32
E. Evaluation and Comparison of Bids	34
F. Award of Contract.....	39
Section III. Bid Data Sheet	42
Section IV. General Conditions of Contract	49
Section V. Special Conditions of Contract.....	78
Section VI. Specifications	79
Section VII. Drawings	148
Section VIII. Bill of Quantities.....	149
Section IX. Philippine Bidding Documents Related Forms.....	151
Section X. Checklist of Technical and Financial Documents	169

Glossary of Acronyms, Terms, and Abbreviations

ABC – Approved Budget for the Contract.

ADR – Alternative Dispute Resolution.

ARCC – Allowable Range of Contract Cost.

BAC – Bids and Awards Committee.

BIR – Bureau of Internal Revenue.

BSP – Bangko Sentral ng Pilipinas.

CDA – Cooperative Development Authority.

COS – Contract of Service.

CPI – Consumer Price Index.

DOLE – Department of Labor and Employment.

DTI – Department of Trade and Industry.

GCC - General Conditions of Contract.

GFI – Government Financial Institution.

GOCC – Government-Owned and/or –Controlled Corporation.

GoP – Government of the Philippines.

GPPB – Government Procurement Policy Board.

HoPE – Head of Procuring Entity.

JO – Job Order.

IRR – Implementing Rules and Regulations.

ITB – Instructions to Bidders.

LCB- Lowest Calculated Bid.

LCRB – Lowest Calculated Responsive Bid.

LGUs – Local Government Units.

LoC – Line of Credit

MAB – Most Advantageous Bid.

MARB – Most Advantageous Responsive Bid.

MEARB – Most Economically Advantageous Responsive Bid.

MYCA – Multi-Year Contracting Authority.

NFCC – Net Financial Contracting Capacity.

NGA – National Government Agency.

PCAB – Philippine Contractors Accreditation Board.

PhilGEPS - Philippine Government Electronic Procurement System.

PSA – Philippine Statistics Authority.

RA No. – Republic Act Number.

SARB – Single Advantageous and Responsive Bid.

SCC - Special Conditions of Contract.

SCRB – Single Calculated and Responsive Bid.

SEARB – Single Economically Advantageous Responsive Bid.

SEC – Securities and Exchange Commission.

SLCC – Single Largest Completed Contract.

SRRB – Single Rated and Responsive Bid.

UN – United Nations.

Definition of Terms

Bid – a signed offer, proposal, or quotation submitted by a supplier, manufacturer, distributor, contractor, consultant, or service provider in response to the requirements of the Procuring Entity as stated in the Bidding Documents. (IRR of RA No. 12009, Section 5[c]).

Bidder – a supplier, manufacturer, distributor, contractor, consultant, and service provider, whether public or private, who submits a Bid in response to the requirements of the Procuring Entity as stated in the Bidding Documents. (IRR of RA No. 12009, Section 5[d]).

Bidding Documents – the documents issued by the Procuring Entity as the basis for Bids, furnishing all information necessary to prospective bidder to prepare a Bid for the Goods, Infrastructure Projects, and Consulting Services required by the Procuring Entity. (IRR of RA No. 12009, Section 5[e])

Bill of Quantities – a list of the specific items of the Work and their corresponding unit prices, lump sums, and/or provisional sums.

Consulting Services – services for Infrastructure Projects and other types of projects or activities of the government requiring adequate external technical and professional expertise that are beyond the capability or capacity of the government to undertake such as, but not limited to: (i) advisory and review services; (ii) pre-investment or feasibility studies; (iii) design; (iv) construction supervision; (v) management and related services; and (vi) other technical services or special studies. (IRR of RA No. 12009, Section 5[i]).

Contract – the agreement entered into between the Procuring Entity and the Contractor to execute, complete, and maintain the Works and as recorded in the Contract Form signed by the parties, including all attachments and appendices thereto and all documents incorporated by reference therein.

Contract Price – the price stated in the Notice of Award and thereafter to be paid by the Procuring Entity to the Contractor for the execution of the Works in accordance with this Contract.

Contract Time Extension (CTE) – the allowable period for the Contractor to complete the Works in addition to the original Completion Date stated in this Contract.

Contractor – a natural or juridical entity whose proposal was accepted by the Procuring Entity and to whom the Contract to execute the Work was awarded. Contractor as used in these Bidding Documents may likewise refer to a supplier, distributor, manufacturer, or consultant.

Days – refers to calendar days; months to calendar months.

Dayworks – varied work inputs subject to payment on a time basis for the Contractor's employees and Equipment, in addition to payments for associated Materials and Plant.

Defect – any part of the Works not completed in accordance with the Contract.

Defects Liability Certificate – the certificate issued by the Procuring Entity upon correction of defects by the Contractor.

Defects Liability Period – the one (1) year period between contract completion and final acceptance within which the Contractor assumes the responsibility to undertake the repair of any damage to the Works at its own expense.

Drawings – graphical presentations of the Works. They include all supplementary details, shop drawings, calculations, and other information provided or approved for the execution of this Contract.

Effective Date of the Contract – the date indicated in the contract. However, the Contractor shall commence performance of its obligations only upon receipt of the Notice to Proceed.

Foreign-funded Procurement or Foreign-Assisted Project – refers to the acquisition of Goods, Consulting Services, and the contracting for Infrastructure Projects by the Government of the Philippines which are wholly or partly funded by foreign loans or grants pursuant to a Treaty or International or Executive Agreement.

Funding Source – Organization named in the SCC.

Goods – refer to (i) all items, supplies, and materials, whether in the nature of equipment, furniture, stationery, materials for construction, or personal property of any kind, needed in the transaction of public businesses or in the pursuit of any government undertaking, project or activity; or (ii) general support services which pertain to all types of services except Consulting Services and Infrastructure Projects, such as the repair and maintenance of equipment and furniture, as well as trucking, hauling, janitorial, security, and related or analogous services. Personnel Services or individual COS or JO engagements do not fall under this definition; (IRR of RA No. 12009, Section 5[n]).

Infrastructure Projects – include the construction, improvement, rehabilitation, demolition, repair, restoration, or maintenance of roads and bridges, railways, airports, seaports, communication facilities, civil works components of information technology projects, irrigation, flood control and drainage, water supply, sanitation, sewerage and solid waste management systems, shore protection, energy/power and electrification facilities, national buildings, school buildings, hospital buildings, and other related construction projects of the government. Also referred to as “civil works” or “works;” (IRR of RA No. 12009, Section 5[r]).

Lot – refers to one or more infrastructure projects that are grouped or bundled together based on factors, such as scope, location, or other relevant parameters, as determined by the End-User or Implementing Unit of the Procuring Entity. Each lot is distinct within the project and may be awarded as a separate contract.

MARB – refers to the award criteria in the procurement of Infrastructure where the considerations for the award of contract are the eligibility of the bidder, the responsiveness of its bid to the technical requirements, and the most advantageous bid in reference to the highest rated offer based on the quality component of the bid.

Materials – refer to all supplies, including consumables, used by the Contractor for incorporation in the Works.

MEARB – refers to the award criteria in the procurement of Infrastructure where the considerations for the award of contract are the eligibility of the bidder, the responsiveness of its bid to the technical requirements, and the determination of the most economically advantageous bid in reference to the quality-price ratio allocated to the technical and financial components of the bid.

Notice to Proceed – refers to a written notice issued by the Procuring Entity to the Contractor requiring the latter to begin the commencement of the work not later than a specified or determinable date.

Online submission – pertains to the submission of the bid for Infrastructure Projects and the bid envelopes containing the technical and financial components of the bid through electronic means or through the electronic bidding facility of the PhilGEPS, once available.

Permanent Works – refer to all permanent structures and all other project features and facilities required to be constructed and completed in accordance with this Contract which shall be delivered to the Procuring Entity, and which shall remain at the Site after the removal of all Temporary Works.

Plant – refers to the machinery, apparatus, and the like intended to form an integral part of the Permanent Works.

Procuring Entity - the organization acquiring the Infrastructure Project, as named in the SCC.

Project – refers to a specific or identified procurement covering Goods, Infrastructure Projects or Consulting Services. A Procurement Project shall be described, detailed, and scheduled in the Project Procurement Management Plan prepared by the agency which shall be consolidated in the Procuring Entity's Annual Procurement Plan.

Program of Work – refers to the big-picture plan and comprehensive schedule that details construction-related tasks to ensure the timely and efficient delivery of the project.

Site Investigation Reports – refers to those that were included in the Bidding Documents and are factual and interpretative reports about the surface and subsurface conditions at the Site.

Slippage – refers to a delay in work execution occurring when actual accomplishment falls below the target as measured by the difference between the scheduled and actual accomplishment of the Work by the Contractor as established from the work schedule. This is actually described as a percentage of the whole Works.

Simple Infrastructure Projects – refers to construction, improvement, rehabilitation, demolition, repair, restoration, or maintenance of structures, technical facilities and systems with an Approved Budget for the Contract (ABC) not exceeding Ten Million Pesos (PhP 10,000,000.00) built at the community level for the sustenance of lives and livelihoods of the population living in a community and built according to the needs and aspirations of the community population.

Verified Report – the report submitted by the Implementing Unit to the HoPE setting forth its findings as to the existence of grounds or causes for termination and explicitly stating its recommendation for the issuance of a Notice to Terminate.

Section I. Invitation to Bid



Republic of the Philippines
PROVINCE OF CAMARINES NORTE
BIDS AND AWARDS COMMITTEE



INVITATION TO BID
for the
Extension of Covered Court and Flooring,
P-4, Brgy. Mampurog, San Lorenzo Ruiz, Camarines Norte

1. The *Provincial Government of Camarines Norte*, through the *20% Development Fund CY2026* intends to apply the sum of *Two Million One Hundred Eighteen Thousand Three Hundred Ninety-Six Pesos and Sixty-Six Centavos (P2,118,396.66)* being the Approved Budget for the Contract (ABC) to payments under the contract for the *Extension of Covered Court and Flooring, P-4, Brgy. Mampurog, San Lorenzo Ruiz, Camarines Norte*. Bids received in excess of the ABC shall be automatically rejected at bid opening.
2. The *Provincial Government of Camarines Norte* now invites bids for the *Construction of Covered Court, 12.60m x 3.50m, including roof extension with new supporting columns; construction of 307.91 sq.m. pavement*. Completion of the Works is required *60 CD*. Bidders should have completed, within *5 years* from date of submission and receipt of bids, a contract similar to the Project. The description of an eligible bidder is contained in the Bidding Documents, particularly, in Section II (Instructions to Bidders).
3. Bidding will be conducted through competitive bidding procedures using non-discretionary "pass/fail" criterion as specified in the IRR, otherwise known as the "New Government Procurement Act (NGPA)."

Bidding is restricted to Filipino citizens/sole proprietorships, cooperatives, and partnerships or organizations with at least sixty percent (60%) interest or outstanding capital stock belonging to citizens of the Philippines.
4. Interested bidders may obtain further information from the *Provincial Government of Camarines Norte* and inspect the Bidding Documents at the address given below from *8:00a.m. to 5:00p.m., Monday to Friday, except Holidays*.
5. A complete set of Bidding Documents may be acquired by interested bidders on *January 27, 2026 – February 10, 2026* at the *Provincial Capitol Building, Daet, Camarines Norte* and upon payment of the applicable fee for the Bidding Documents, pursuant to the latest Guidelines issued by the GPPB, in the amount of *Five Thousand Pesos (P5,000.00)*.

It may also be downloaded free of charge from the website of the Philippine Government Electronic Procurement System (PhilGEPS) and the website of the Procuring Entity, provided that bidders shall pay the applicable fee for the Bidding Documents not later than the submission of their bids.
6. Bids must be duly received by the Bids and Awards Committee (BAC) Secretariat through **manual submission** at the address below on or before *February 10, 2026 at 1:30p.m.* Late bids shall not be accepted.
7. All bids must be accompanied by a Bid Security in any of the acceptable forms and in the amount stated in **ITB Clause 16**.

8. Bid opening shall be on *February 10, 2026, 2:00 p.m. onwards* at the *Provincial Capitol Building, Daet, Camarines Norte*. Bids will be opened in the presence of the bidders' representatives who choose to attend the activity, provided that an Authorization Letter shall be submitted to the BAC on or before the scheduled opening of bids. **Only one (1) representative for each Bidder may physically attend the bid opening.**
9. The Bid Evaluation and Award Criteria are **Lowest Calculated Bid (LCB)** and **Lowest Calculated and Responsive Bid (LCRB)**, respectively.
10. The *Provincial Government of Camarines Norte* reserves the right to reject any and all bids, declare a failure of bidding, or not award the contract at any time prior to contract award in accordance with Section 70 of R.A. No. 12009, without thereby incurring any liability to the affected bidder or bidders.
11. For further information, please refer to:

ENGR. ALMIRANTE A. ABAD
Provincial Agriculturist / Head, BAC Secretariat
Bids and Awards Committee Office,
Provincial Capitol Bldg., Daet, Camarines Norte
baccamnorte2025@gmail.com
12. You may visit the website:

For downloading of Bidding Documents:

Philippine Government Electronic Procurement System (PhilGEPS)

Provincial Government of Camarines Norte Official Website (www.camsnorte.com)

ATTY. ARCHIMEDES O. YANTO
Provincial Legal Officer / BAC Chairperson



Section II. Instructions to Bidders

TABLE OF CONTENTS

A. GENERAL	17
1. Scope of Bid	17
2. Source of Funds	17
3. Corrupt, Fraudulent, Collusive, Coercive, and Obstructive Practices.....	17
4. Conflict of Interest	18
5. Eligible Bidders	19
6. Bidder’s Responsibilities.....	21
7. Origin of Goods and Services.....	23
8. Subcontracts	23
B. CONTENTS OF BIDDING DOCUMENTS	24
9. Pre-Bid Conference.....	24
10. Clarification and Amendment of Bidding Documents.....	24
C. PREPARATION OF BIDS	25
11. Language of Bids	25
12. Documents Comprising the Bid: Technical and Financial Components.....	25
13. Bid Prices	27
14. Bid Currencies	27
15. Bid Validity	27
16. Bid Security	27
17. Format and Signing of Bids.....	31
18. Sealing and Marking of Bids	31
D. SUBMISSION AND OPENING OF BIDS	32
19. Deadline for Submission of Bids	32
20. Late Bids	32
21. Modification and Withdrawal of Bids.....	32
22. Opening and Preliminary Examination of Bids	33
E. EVALUATION AND COMPARISON OF BIDS	34
23. Process to be Confidential.....	34
24. Clarification of Bids.....	34
25. Detailed Evaluation and Comparison of Bids	34
26. Post-Qualification	36

27.	Reservation Clause	38
F.	AWARD OF CONTRACT.....	39
28.	Contract Award.....	39
29.	Signing of the Contract	39
30.	Performance Security	40
31.	Notice to Proceed.....	41
32.	Protest Mechanism.....	41

A. General

1) Scope of Bid

- 1.1 The Procuring Entity, **Provincial Government of Camarines Norte**, invites Bids for the **Extension of Covered Court and Flooring, P-4, Brgy. Mampurog, San Lorenzo Ruiz, Camarines Norte**, with Project Identification Number **ITB-2026-032**.

The Procurement Project (referred to herein as “Project”) is for the construction of Works, as described in Section VI (Specifications).

- 1.2 The winning Bidder will be expected to complete the Works by the intended completion date specified in **SCC Clause 1.1**.

2) Source of Funds

The Procuring Entity has a budget or received funds from the Funding Source named in the **BDS**, and in the amount indicated in the **BDS**. It intends to apply part of the funds received for this Project to cover eligible payments under the contract.

3) Corrupt, Fraudulent, Collusive, Coercive, and Obstructive Practices

- 3.1 Unless otherwise specified in the **BDS**, the Procuring Entity, as well as Bidders and Contractors, shall observe the highest standard of ethics during the procurement and execution of the contract. In pursuance of this policy, the Procuring Entity:

- a) defines, for purposes of this provision, the following terms under existing laws, rules, and regulations:
- i) "corrupt practice" means an act by which officials in the public or private sectors improperly and unlawfully enrich themselves, others, or induce others to do so, by misusing the position in which they are placed, and includes the offering, giving, receiving, or soliciting of anything of value to influence the action of any such official in the procurement process or in contract execution; entering, on behalf of the government, into any contract or transaction manifestly and grossly disadvantageous to the same, whether or not the public officer profited or will profit thereby, and similar acts as provided in RA No. 3019.
 - ii) "fraudulent practice" means a misrepresentation of facts for purposes of influencing a procurement process or the execution of a contract to the detriment of the Procuring Entity, which includes collusive practices among Bidders (prior to or after bid submission) designed to establish bid prices at artificial, non-competitive levels and to deprive the Procuring Entity of the benefits of free and open competition.
 - iii) “collusive practices” means a scheme or arrangement between two or more Bidders, with or without the knowledge of the Procuring Entity, designed to establish bid prices at artificial, non-competitive levels.
 - iv) “coercive practices” means harming or threatening to harm, directly or indirectly, persons, or their property to influence their participation in a procurement process, or affect the execution of a contract;
 - v) “obstructive practice” is

- a) deliberately destroying, falsifying, altering or concealing of evidence material to an administrative proceedings or investigation or making false statements to investigators in order to materially impede an administrative proceedings or investigation of the Procuring Entity or any foreign government/foreign or international financing institution relative to allegations of a corrupt, fraudulent, coercive or collusive practice; and/or threatening, harassing or intimidating any party to prevent the latter from disclosing its knowledge of matters relevant to the administrative proceedings or from pursuing such proceedings or investigation; or
 - b) acts intended to materially impede the exercise of the inspection and audit rights of the Procuring Entity or any foreign government/foreign or international financing institution herein.
 - b) Undertakes to reject a proposal for award upon *prima facie* determination that the Bidder recommended for award has engaged in any of the prohibited practices mentioned in this Clause for purposes of competing for the contract.
- 3.2 Further, the Procuring Entity will seek to impose the maximum civil, administrative, and/or criminal penalties available under the applicable laws on individuals and organizations deemed to be involved in any of the practices mentioned in **ITB** Clause 4.
- 3.3 Furthermore, the Funding Source and the Procuring Entity reserve the right to inspect and audit records and accounts of a Bidder or Contractor in the bidding for and performance of a contract themselves or through independent auditors as reflected in the **GCC** Clause 36.

4) Conflict of Interest

- 4.1 All Bidders found to have conflicting interests shall be disqualified to participate in the procurement at hand, without prejudice to the imposition of appropriate administrative, civil, and criminal sanctions. A Bidder may be considered to have conflicting interests with another Bidder in any of the events described in paragraphs (a) through (c) and a general conflict of interest in any of the circumstances set out in paragraphs (d) through (f) below:
- a) A Bidder has controlling shareholders or beneficial owners in common with another Bidder;
 - b) A Bidder receives or has received any direct or indirect subsidy from any other Bidder;
 - c) A bidder has the same legally authorized representative as that of another Bidder for purposes of this Bid;
 - d) A bidder has a relationship, directly or through third parties, that puts them in a position to have access to information about or influence on the bid of another Bidder or influence the decisions of the Procuring Entity regarding this bidding process. This may include a firm or an organization that lends, or temporarily seconds, its personnel to firms or organizations that are engaged in consulting services for the preparation related to procurement for or implementation of

the project if the personnel would be involved in any capacity on the same project;

- e) A bidder who participated as a consultant in the preparation of the design or technical specifications of the goods and related services that are the subject of the bid; or
 - f) A bidder who lends, or temporarily seconds, its personnel to firms or organizations which are engaged in consulting services for the preparation related to procurement for or implementation of the project, if the personnel would be involved in any capacity on the same project.
- 4.2 All Bidding Documents shall be accompanied by an Omnibus Sworn Statement of the Bidder that it is not related, by consanguinity or affinity up to the third civil degree, to the HoPE, Procurement Agent (if engaged), the head of the Project Management Office (PMO), the End-User or Implementing Unit or any members of the Bids and Awards Committee (BAC), Technical Working Group (TWG), and BAC Secretariat.³
- 4.3 The Bidder shall also disclose the ultimate beneficial ownership of the entity it represents. Failure to comply shall be a ground for the automatic disqualification of the bid in consonance with Section 59 of the IRR. For this reason, relationship to the aforementioned persons within the third civil degree of consanguinity or affinity shall automatically disqualify the Bidder from participating in the procurement of contracts of the Procuring Entity notwithstanding the act of such persons inhibiting themselves from the procurement process. This Clause shall apply to the following persons and affiliates:
- a) In the case of individuals or sole proprietorships, to the Bidders and their spouses;
 - b) In the case of partnerships, to the partnership itself and its partners;
 - c) In the case of cooperatives, to the cooperative itself and members of the board of directors, general manager or chief executive officer;
 - d) In the case of a partnership, joint venture, or consortium, to the entity itself, its members or partners, as well as any person or entity that is a member of a blacklisted partnership, joint venture, or consortium; and
 - e) In the case of corporations, a single stockholder, together with their relatives up to the third civil degree of consanguinity or affinity, and their assignees, holding at least twenty percent (20%) of the shares therein, its chairperson and president, shall be blacklisted after they have been determined to hold the same controlling interest in a previously blacklisted corporation or in two corporations that have been blacklisted; the corporations of which they are part shall also be blacklisted.

5) Eligible Bidders

³ Section 81.1 of the IRR.

- 5.1 Only Bids found to be legally, technically, and financially eligible will be evaluated. For procurement of Infrastructure Projects, the following persons shall be eligible to participate in this bidding:
- a) Duly licensed Filipino citizens or sole proprietorships;
 - b) Partnerships duly organized under the laws of the Philippines and of which at least sixty percent (60%) of the interest belongs to citizens of the Philippines;
 - c) Corporations duly organized under the laws of the Philippines, and of which at least sixty percent (60%) of the outstanding capital stock belongs to citizens of the Philippines;
 - d) Cooperatives duly organized under the laws of the Philippines; and
 - e) Persons or entities forming themselves into a Joint Venture (JV), i.e., a group of two (2) or more persons or entities that intend to be jointly and severally responsible or liable for a particular contract; Provided, however, that in accordance with relevant laws, rules, and regulations, Filipino ownership or interest of the joint venture concerned shall be at least sixty percent (60%); Provided, further, that joint ventures in which Filipino ownership or interest is less than sixty percent (60%) may be eligible where the structures to be built require the application of techniques or technologies which are not adequately possessed by a person or entity meeting the sixty percent (60%) Filipino ownership requirement; Provided, furthermore, that in the latter case, Filipino ownership or interest shall not be less than twenty-five percent (25%). For this purpose, Filipino ownership or interest shall be based on the contributions of each of the member of the joint venture as specified in their Joint Venture Agreement (JVA); Provided, finally, that the primary purpose of each member of the joint venture must be similar or related to the requirement of the project to be bid out.
- 5.2 The Procuring Entity may also invite foreign bidders when provided for under any Treaty or International or Executive Agreement as specified in the **BDS**.
- 5.3 In accordance with RA No. 4566 or the “Contractors' License Law” as amended by RA No. 11711 or “An Act Further Amending Republic Act No. 4566”, the persons or entities enumerated in Section 52 of the IRR may participate in the procurement of Infrastructure Projects if it has been issued a license by the Philippine Contractors Accreditation Board (PCAB) to engage or act as a contractor.
- 5.4 The Bidder must have completed an SLCC that is similar to the procurement project to be bid, and whose value must be equivalent to at least fifty percent (50%) of the ABC, adjusted to current prices using the Philippine Statistics Authority (PSA) consumer price indices; Provided, that any change to the fifty percent (50%) requirement may be allowed, subject to the recommendation of the Procuring Entity, which shall be submitted to the GPPB for consideration; Provided, further, that contractors under Small A and Small B categories without similar experience on the procurement project to be bid may be allowed to bid if the cost of such contract is not more than the Allowable Range of Contract Cost of their registration based on the guidelines as prescribed by the PCAB.

For foreign-funded procurement, the GoP and the foreign government, or foreign or international financing institution may agree on another track record requirement, as specified in the **BDS**.

Moreover, a contract shall be considered similar to the procurement project if it has the same major categories of work. The Procuring Entity may clarify in the Bidding Documents what is regarded as major categories of work, guided by the principle of proportionality and Fit-for-Purpose approach.

- 5.5 The SLCC shall be supported by an Owner's Certificate of Final Acceptance issued by the project owner other than the Contractor, or a final rating of at least Satisfactory in the Constructors Performance Evaluation System (CPES), or a similar performance and monitoring system. In the case of contracts with the private sector, an equivalent document shall be submitted.
- 5.6 The computation of a bidder's NFCC must be at least equal to the ABC to be bid, calculated as follows:

NFCC = [(Current assets minus current liabilities) (15)] minus the value of all outstanding or uncompleted portions of the projects under ongoing contracts, including awarded contracts yet to be started, coinciding with the procurement project to be bid; Provided, That a different formula may be adopted subject to the recommendation of the Procuring Entity, which shall be submitted to the GPPB for consideration.

The value of the domestic bidder's current assets and current liabilities shall be based on the latest AFS submitted to the BIR.

For purposes of computing the foreign bidders' NFCC, the value of the current assets and current liabilities shall be based on their latest AFS prepared in accordance with international financial reporting standards.

6) Bidder's Responsibilities

- 6.1 The Bidder or its duly authorized representative shall submit a sworn statement in the form prescribed in Section IX. Philippine Bidding Documents Related Forms as required in ITB Clause 12.1(h)(iv).
- 6.2 Before submitting their bids, the Bidders are deemed to be knowledgeable of all existing laws, decrees, ordinances, acts and regulations of the Philippines which may affect this Project in any way.
- 6.3 The Bidder undertook the following responsibilities:
 - a) Took steps to carefully examine and ensure full understanding and comprehension of the Bidding Document, its requirements, clauses, and provisions;
 - b) Acknowledged all conditions, local or otherwise, affecting the implementation of the contract;
 - c) Made an estimate of the facilities available and needed for the contract to be bid, if any;
 - d) Complied with its responsibility to inquire or secure Supplemental Bid Bulletin(s);
 - e) Ensured that it is not "blacklisted" or barred from bidding by the Government of the Philippines (GoP) or any of its agencies, offices, corporations, or LGUs,

including foreign government, or foreign/ international financing institutions whose blacklisting rules have been recognized by the GPPB; by itself or by reason of its relation, membership, association, affiliation, or controlling interest with another blacklisted person or entity;

- f) Ensured that each of the documents submitted in satisfaction of the bidding requirements is an authentic copy of the original, complete, and that all statements and information provided therein are true and correct;
- g) Authorized the HoPE or its duly authorized representative/s to verify all the documents submitted;
- h) Ensured that the signatory is the duly authorized representative of the Bidder, and granted full power and authority to do, execute and perform any and all acts necessary to participate, submit the bid, to sign, and execute the ensuing contract, accompanied by the duly notarized Special Power of Attorney, Board or Partnership Resolution, or Secretary's Certificate, whichever is applicable;
- i) Complied with the disclosure provision under Section 81 and 82 of RA No. 12009 and its IRR in relation to other provisions of RA No. 3019;
- j) Complied with existing labor laws and standards. Moreover, the Bidder undertakes to:
 - i) Ensure the entitlement of workers to wages, hours of work, safety and health and other prevailing conditions of work as established by national laws, rules and regulations; or Collective Bargaining Agreement (CBA) or arbitration award, if and when applicable.

In case there is a finding by the Procuring Entity or the Department of Labor and Employment (DOLE) of underpayment or non-payment of workers' wages and wage-related benefits, the Bidder agrees that the performance security or portion of the contract amount shall be withheld in favor of the complaining workers pursuant to appropriate provisions of RA No. 12009, without prejudice to the institution of appropriate actions under the Labor Code, as amended, and other social legislations;
 - ii) Comply with Occupational Safety and Health Standards (OSHS) and correct deficiencies, if any.

In case of imminent danger, injury or death of the worker, the Bidder undertakes to suspend contract implementation pending clearance to resume from the DOLE Regional Office, in compliance with the Work Stoppage Order; and
 - iii) Inform the workers of their conditions of work, labor clauses under the contract specifying wages, hours of work and other benefits under prevailing national laws, rules and regulations; or CBA or arbitration award, if and when applicable, through posting in two (2) conspicuous places in the establishment's premises.
- k) Ensured that it did not give or pay, directly or indirectly, any commission, amount, fee, or any form of consideration, pecuniary or otherwise, to any

person or official, personnel or representative of the government in relation to any procurement project or activity;

- l) Examined all instructions, forms, terms, and specifications in the Bidding Documents;
- m) Determined and complied with all matters pertaining to the contract to be bid, including but not limited to: (i) the location and the nature of the contract, project, or work; (ii) climatic conditions; (iii) transportation facilities; (iv) nature and condition of the terrain, geological conditions at the site communication facilities, requirements, location and availability of construction aggregates and other materials, labor, water, electric power and access roads; and (v) other factors that may affect the cost, duration and execution or implementation of the contract, project, or work; and
- n) Ensured that all information in the Bidding Documents, including bid or supplemental bid bulletin(s) issued, are correct and consistent. The Procuring Entity shall not assume any responsibility regarding erroneous interpretations or conclusions by the prospective or eligible Bidder out of the data furnished by the Procuring Entity.

Failure to observe any of the above responsibilities shall be at the risk of the Bidder concerned;

- 6.4 The Bidder, by the act of submitting its bid, shall be deemed to have inspected the site, determined the general characteristics of the contract works and the conditions for this Project and examine all instructions, forms, terms, and project requirements in the Bidding Documents.
- 6.5 Further, the Bidder shall bear all costs associated with the preparation and submission of its bid, and the Procuring Entity shall in no case be responsible or liable for those costs, regardless of the conduct or outcome of the bidding process.

In case of failure of bidding, the Bidding Documents fee may be applied in the re-bidding for the same Project.

- 6.6 Furthermore, the Bidder should be aware that the Procuring Entity will accept bids only from those that have paid the applicable fee for the Bidding Documents at the office indicated in the Invitation to Bid.

7) **Origin of Goods and Services**

Unless otherwise indicated in the **BDS**, there is no restriction on the origin of Goods, or Contracting of Works or Services other than those prohibited by a decision of the United Nations Security Council taken under Chapter VII of the Charter of the United Nations.

8) **Subcontracts**

- 8.1 Unless otherwise specified in the **BDS**, the Bidder may subcontract portions of the Works to an extent as may be approved by the HoPE and as stated in the **BDS**. However, the subcontracted portion shall not exceed fifty (50%), or a different percentage of the ABC, on a per project basis, as approved by the GPPB.
- 8.2 Subcontracting of any portion of the Project shall not relieve the Bidder from any liability or obligation that may arise from the contract.

- 8.3 Subcontractors must meet the eligibility criteria as stated in the **BDS** and shall submit the same eligibility documents as the general contractor. Failure of a subcontractor to meet the eligibility criteria does not affect the eligibility of the general contractor for the procurement project. In such case, the portion intended to be subcontracted to the ineligible subcontractor shall be assumed by the general contractor.
- 8.4 Subcontracting arrangement, if allowed, including the time of submission of the eligibility documents of the subcontractor, shall be disclosed in the **BDS**.

B. Contents of Bidding Documents

9) Pre-Bid Conference

- 9.1 If so specified in the **BDS**, a pre-bid conference shall be held either at the Procuring Entity's physical address and/or online through videoconferencing, webcasting, or similar technology, or a combination thereof, on the date indicated therein, to clarify and address the Bidders' questions on the technical and financial components of this Project.
- 9.2 The pre-bid conference shall be held at least twelve (12) calendar days before the deadline for the submission of and receipt of bids, but not earlier than seven (7) calendar days from the posting of the invitation to bid and other bidding documents on the PhilGEPS website.
- 9.3 Bidders are highly encouraged to attend the pre-bid conference to fully understand the Procuring Entity's requirements. While non-attendance of the Bidder will in no way prejudice its bid, the Bidder is deemed to know any changes and/or amendments to the Bidding Documents, as may be provided in the Supplemental Bid Bulletin.
- The proceedings of the pre-bid conference shall be recorded, and the corresponding minutes shall be prepared not later than five (5) calendar days after the pre-bid conference. The minutes shall be made available to prospective Bidders not later than five (5) days upon written request.
- 9.4 Decisions of the BAC amending any provision of the Bidding Documents shall be issued in writing through a Supplemental Bid Bulletin at least seven (7) calendar days before the deadline for the submission and receipt of bids.

10) Clarification and Amendment of Bidding Documents

- 10.1 Prospective bidders may request for clarification(s) on and/or interpretation of any part of the Bidding Documents. Such a request must be in writing and submitted to the BAC of the Procuring Entity at the address or electronic mail indicated in the **BDS** or through the electronic bidding facility of PhilGEPS, as may be applicable, at least ten (10) calendar days before the deadline set for the submission and receipt of Bids.
- 10.2 The BAC shall respond to the said request by issuing a Supplemental Bid Bulletin duly signed by the BAC Chairperson. It shall be made available to all those who have properly secured the Bidding Documents, at least seven (7) calendar days before the deadline for the submission and receipt of Bids.
- 10.3 Supplemental Bid Bulletins may also be issued upon the Procuring Entity's initiative for purposes of clarifying or modifying any provision of the Bidding Documents not later than seven (7) calendar days before the deadline for the submission and receipt of Bids. Any modification to the Bidding Documents shall be identified as an amendment.

- 10.4 Any Supplemental Bid Bulletin issued by the BAC shall also be posted on the PhilGEPS website, in any conspicuous place in the premises of the Procuring Entity, and on the website or social media platforms of the Procuring Entity, if available, or such other channels as may be authorized by the GPPB. It shall be the responsibility of all prospective bidders, including those who have properly secured the Bidding Documents, to inquire and secure Supplemental Bid Bulletins that may be issued by the BAC. However, Bidders who have submitted bids before the issuance of the Supplemental Bid Bulletin must be accordingly informed by the BAC, and be allowed to modify or withdraw their bids prior to the deadline for the submission and receipt of bids in accordance with ITB Clause 21.

C. Preparation of Bids

11) Language of Bids

The eligibility requirements or statements, the bids, and all other documents to be submitted to the BAC must be in English. If the eligibility requirements or statements, the bids, and all other documents submitted to the BAC are in foreign language other than English, it must be accompanied by a translation of the documents in English. The documents shall be translated by the relevant foreign government agency, the foreign government agency authorized to translate documents, or a registered translator in the foreign bidder's country. The Bidder shall cause the authentication of the translated documents and shall be authenticated by the appropriate Philippine foreign service establishment or post or the equivalent office having jurisdiction over the foreign bidder's affairs in the Philippines. However, for Contracting Parties to the Apostille Convention, the documents shall be authenticated through an apostille by the Competent Authority, as defined in Section 20.2.9.2 of the IRR, except for countries identified by the DFA that will still require legalization (red ribbon) by the relevant Embassy or Consulate. The English translation shall govern, for purposes of interpretation of the bid.

12) Documents Comprising the Bid: Technical and Financial Components

12.1 The first bid envelope shall contain the following technical documents, including the eligibility documents:

- a) PhilGEPS Certificate of Registration (Platinum Membership) in accordance with Section 20 of the IRR;
- b) PCAB License and Registration, in case of Joint Venture (JV);
- c) Statement of all its ongoing government and private contracts, including contracts awarded but not yet started, if any, whether similar or not similar in nature and complexity to the contract to be bid;
- d) Statement of the Bidder's SLCC, in accordance with **ITB** Clause 5.5.

The SLCC shall be supported by an Owner's Certificate of Final Acceptance issued by the project owner other than the Contractor, or a final rating of at least satisfactory in the CPES, or a similar performance and monitoring system. In case of contracts with the private sector, an equivalent document shall be submitted;

- e) NFCC computation in accordance with **ITB** Clause 5.6;
- f) Joint Venture Agreement (JVA), if applicable;

- g) Bid Security in the prescribed form and amount in accordance with **ITB** Clause 16, and validity period under **ITB** Clause 15;
 - h) Project Requirements, which shall include the following:
 - i) Organizational chart of the personnel to be deployed for the procurement project to be bid;
 - ii) List of Contractor's personnel (e.g., Project Manager, Project Engineers, Materials Engineers, and Foremen), to be assigned to the procurement project to be bid, with their complete qualifications and experience data. These personnel must meet the required minimum years of experience set in the **BDS**;
 - iii) List of Contractor's major equipment units which are owned, leased, or under purchase agreements, supported by proof of ownership or certification of availability of equipment from the equipment lessor or vendor for the duration of the project, as the case may be, which must meet the minimum requirements for the contract set in the **BDS**; and
 - iv) Omnibus Sworn Statement in accordance with Section 54.3 of the IRR.
- 12.2 The second bid envelope shall contain the Financial Bid Form, which includes the bid prices and the bill of quantities, in accordance with **ITB** Clauses 13.1.
- 12.3 Whenever necessary, modifications may be made to the foregoing provisions specifically for major and specialized procurement to suit the particular needs of the Procuring Entity, subject to the approval of the GPPB.
- 12.4 All bids that exceed the ABC shall not be accepted. Unless otherwise indicated in the **BDS**, for foreign-funded procurement, the ABC shall be applied as the ceiling to bid prices provided the following conditions are met:
- a) Bidding Documents are obtainable free of charge on a freely accessible website. If payment of Bidding Documents is required by the Procuring Entity, payment could be made upon the submission of bids.
 - b) The Procuring Entity has procedures in place to ensure that the ABC is based on recent estimates made by the engineer or the responsible unit of the Procuring Entity and that the estimates are based on adequate detailed engineering and reflect the quality, supervision and risk, and inflationary factors, as well as prevailing market prices, associated with the types of works or goods to be procured.
 - c) The Procuring Entity has trained cost estimators on estimating prices and analyzing bid variances. In the case of Infrastructure Projects, the Procuring Entity must also have trained quantity surveyors.
 - d) The Procuring Entity has established a system to monitor and report bid prices relative to ABC and engineer's or Procuring Entity's estimate.
 - e) The Procuring Entity has established a monitoring and evaluation system for contract implementation to provide feedback on actual total costs of goods and works.

However, the GoP and the foreign government, or foreign or international financing institutions may agree to waive the foregoing conditions.

13) Bid Prices

- 13.1 The contract shall be for the whole Works, as described in the Bidding Documents, based on the priced Bill of Quantities submitted by the Bidder.
- 13.2 The Bidder shall fill in rates and prices for all items of the Works described in the Bill of Quantities. In case partial bids are allowed in the ITB, bids not addressing or providing all of the required items in the Bidding Documents including, where applicable, the Bill of Quantities, shall be considered non-responsive and shall be automatically disqualified. In this regard, where a required item is provided, but no price is indicated, the same shall be considered as non-responsive, but specifying a zero (0) or a dash (-) for the said item would mean that it is being offered for free to the Government, except those required by law or regulations to be provided for.
- 13.3 For the given scope of work in the contract as awarded, all bid prices shall be considered as fixed prices, and therefore not subject to price escalation during contract implementation, except under extraordinary circumstances as specified in GCC Clause 45.

14) Bid Currencies

- 14.1 All bid prices shall be quoted in Philippine Peso unless otherwise provided in the **BDS**. However, for purposes of bid evaluation, bids denominated in foreign currencies shall be converted to Philippine currency based on the exchange rate as published in the BSP Daily Reference Exchange Rate Bulletin on the day of the bid opening.⁴
- 14.2 If so allowed in accordance with **ITB** Clause 14.1, the Procuring Entity, for purposes of bid evaluation and comparing the bid prices, will convert the currencies in which the bid price is expressed to Philippine Peso at the foreign exchange rates.
- 14.3 Unless otherwise specified in the **BDS**, payment of the contract price shall be made in Philippine Peso.

15) Bid Validity

- 15.1 Bids shall remain valid for the period specified in the **BDS** which shall not exceed one hundred twenty (120) calendar days from the date of the opening of bids.
- 15.2 Should it become necessary to extend the validity of the bids and the bid securities beyond one hundred twenty (120) calendar days, the Procuring Entity concerned shall request in writing all those who submitted bids for such extension before the expiration date therefor. Bidders, however, shall have the right to refuse to grant such extension without forfeiting their Bid Security.

16) Bid Security

⁴ RA No. 8183 or "An Act to Assure Uniform Value to Philippine Coin and Currency."

- 16.1 The Bidder, at its option, shall submit a Bid Security in the form and amount as stated in the **BDS**, which may include the following:

Form of Bid Security	Amount of Bid Security (Not less than the required Percentage of the ABC)
(a) Cash or cashier's/manager's check issued by a bank. <i>For biddings conducted by LGUs, the Cashier's or Manager's check may be issued by other banks certified by the BSP as authorized to issue such financial instrument.</i>	Two percent (2%)
(b) Bank draft/guarantee or irrevocable Letter of Credit issued by a bank; Provided, however, that it shall be confirmed or authenticated by a local bank, if issued by a foreign bank. <i>For biddings conducted by LGUs, the Bank Draft/Guarantee, or irrevocable letter of credit may be issued by other banks certified by the BSP as authorized to issue such financial instrument.</i>	Five percent (5%)
(c) Surety bond callable upon demand issued by a surety or insurance company duly certified by the Insurance on as authorized to issue such security.	Five percent (5%)
(d) Bid Securing Declaration	Not Applicable

The Bid Security shall be denominated in Philippine Peso and posted in favor of the Procuring Entity.

- 16.2 The Bid Security should be valid for the period specified in the **BDS**. Any bid not accompanied by an acceptable Bid Security shall be considered as non-responsive and rejected by the Procuring Entity.
- 16.3 In no case shall the Bid Security be returned later than the expiration of the bid validity period indicated in the Bidding Documents, unless it has been extended in accordance with Section 57.2 of the IRR. In case the bidder is required to extend its bid validity, the bidder may, at its discretion, substitute a Bid Securing Declaration for the extended period as a replacement of its Bid Security; Provided, that the option to substitute is indicated in the **BDS**.
- 16.4 Upon signing and execution of the contract, pursuant to **ITB** Clause 29, and the posting of the performance security pursuant to **ITB** Clause 30, the Bid Security of the successful Bidder's Bid Security will be discharged, but in no case later than its validity period as indicated in **ITB** Clause 15.

16.5 The Bid Security may be forfeited based on any of the following grounds, as provided under Rule VIII, X, XI, and XXI of the IRR:

a) If a Bidder:

- i) With the Lowest Calculated Responsive Bid (LCRB), Most Economically Advantageous Responsive Bid (MEARB), Most Advantageous Responsive Bid (MARB), Single Calculated and Responsive Bid (SCRB), Single Economically Advantageous Responsive Bid (SEARB), or Single Advantageous Responsive Bid (SARB) withdraws, fails, refuses or is unable to: (i) submit the documents required under Section 66.5 of the IRR; (ii) enter into contract with the Procuring Entity; or (iii) post the required performance security within the period stipulated in the IRR and in accordance with **ITB** Clause 30;
- ii) Causes the delay, without justifiable cause, of the screening for eligibility, opening of bids, evaluation and post evaluation of Bids, and awarding of contracts;
- iii) Refuses to clarify or validate in writing its bid during post-qualification within a period of seven (7) calendar days from receipt of the request for clarification;
- iv) Withdraws a bid, or refuses to accept an award, or refuses or fails to enter into contract with the Procuring Entity without justifiable cause, after the approval of the HoPE for having been the declared LCRB or MEARB, as the case may be;
- v) Refuses or fails to furnish performance security within the prescribed time;
- vi) Commits of three (3) or more of any of the acts imposed with suspension, as provided under Section 99 of the IRR;
- vii) Uses force, fraudulent machinations, coercion, undue influence or pressure on any member of the BAC or any officer or employee of the Procuring Entity to take a particular action for its own favor or gain, or to the advantage of a particular bidder;
- viii) Colludes with one (1) or more bidders and submitting different bids as if they were bona fide, when they knew that one or more of them was so much higher than the other that it could not be honestly accepted and that the contract will surely be awarded to the pre-arranged lowest bid;
- ix) Maliciously submits different bids through two (2) or more persons, corporations, partnerships, or any other business entity in which it has interest, to create the appearance of competition that does not in fact exist so as to be declared as the winning bidder;
- x) Enters into an agreement with other bidder/s which call upon one to refrain from bidding for procurement contracts, or which call for withdrawal of bids already submitted, or which are otherwise intended to secure an undue advantage to any of the bidders;

- xi) Fails to faithfully disclose its relationship, regardless of the time of its discovery, with the HoPE, members of the BAC, the TWG, and the BAC Secretariat, the head of the PMO or the End-User or Implementing Unit, and the project consultants of the Procuring Entity, or of the procurement agent, whichever is applicable, by consanguinity or affinity up to the third civil degree pursuant to Section 81 of the IRR;
 - xii) Submits beneficial ownership information containing false entries;
 - xiii) Allows the use of one's name or uses the name of another for purposes of public bidding;
 - xiv) Submits eligibility requirements and bids containing false information or falsified documents or the concealment of such information that will materially alter the outcome of eligibility screening or any stage of the procurement;
 - xv) Accesses the contents of any Bid submitted to the Procuring Entity before the opening of bids, without authorization;
 - xvi) Has any documented attempt to unduly influence the outcome of the bidding;
 - xv) Employs schemes which stifle or suppress any procurement activity; or
 - xvi) Commits a third offense imposed with blacklisting under the Act by the same Procuring Entity, or a combination of three (3) violations imposed with blacklisting by the Procuring Entity and other Procuring Entities, as posted on the GPPB portal;
- b) If a Winning Bidder:
- i) Conducts poor performance or unsatisfactory quality and/or progress of work. Poor performance shall be as follows:
 - i.i) Negative slippage of fifteen percent (15%) and above within the critical path of the project due entirely to the fault or negligence of the winning bidder; or
 - i.ii) Non-compliance of the materials and workmanship with the approved specifications arising from the fault or negligence of the winning bidder.
 - ii) In case it is determined prima facie that the winning bidder has engaged, before or during the implementation of the contract, in the following unlawful deeds and behaviors relative to contract acquisition and implementation:
 - ii.i) Corrupt, fraudulent, collusive and coercive practices;
 - ii.ii) Drawing up or using forged documents; or

- ii.iii) Using adulterated materials, means or methods, or engaging in production contrary to rules of science or trade.
- iii) Assigns or subcontracts the contract or any part thereof or substituting key personnel named in the proposal without prior written approval by the Procuring Entity;
- iv) Willfully or deliberately abandons or does not perform the project or contract by the winning bidder resulting in substantial breach thereof without lawful and/or just cause;
- v) Has its contract terminated due to its default or unlawful acts; or
- vi) Fails to comply with the provision on warranty that requires to repair any noted defect or damage to the Infrastructure Project due to the use of materials of inferior quality within ninety (90) calendar days from the issuance of the order by the HoPE to undertake such repairs.

17) Format and Signing of Bids

- 17.1 Bidders shall submit their bids through their duly authorized representative using the appropriate forms provided in Section IX. Philippine Bidding Documents Related Forms on or before the deadline specified in the **ITB** Clause 19 in two (2) separate sealed bid envelopes which shall be submitted simultaneously, whether through manual or online submission. The first shall contain the technical component of the bid, including the eligibility requirements under **ITB** Clause 12, and the second shall contain the financial component of the bid.
- 17.2 Forms as mentioned in **ITB** Clause 17.1 must be completed without any alterations to their format. No substitute form shall be accepted.
- 17.3 Each and every page of the Bid Form, including the Bill of Quantities, under Section IX hereof, shall be signed by the duly authorized representative/s of the Bidder. Failure to do so shall be a ground for the rejection of the bid.
- 17.4 Any insertions, erasures, or overwriting shall be valid only if they are signed or initialed by the duly authorized representative/s of the Bidder.

18) Sealing and Marking of Bids

- 18.1 Bidders shall enclose their technical documents described in **ITB** Clause 12 in one sealed envelope marked “TECHNICAL COMPONENT,” and the financial component in another sealed envelope marked “FINANCIAL COMPONENT,” sealing them all in an outer envelope marked “BID.”
- 18.2 The Bid shall be typed or written in ink and shall be signed by the Bidder or its duly authorized representative/s.
- 18.3 All envelopes shall:
 - a) contain the name of the contract to be bid in capital letters;
 - b) bear the name and address of the Bidder in capital letters;

- c) be addressed to the Procuring Entity’s BAC in accordance with **ITB** Clause 18.1;
 - d) bear the specific identification of this bidding process indicated in the **ITB** Clause 1.1; and
 - e) bear a warning “DO NOT OPEN BEFORE...” the date and time for the opening of bids, in accordance with **ITB** Clause 19.
- 18.4 For manually submitted bid envelopes that are not properly sealed and marked, as required in the Bidding Documents, the same shall be accepted; Provided, That the bidder or its duly authorized representative shall acknowledge such condition of the bid as submitted. On the other hand, unsealed or unmarked bid envelopes, or bids that cannot be opened or corrupted in case of online submission, shall be rejected.

The BAC shall assume no responsibility for misplaced or lost contents of the improperly sealed or marked bid, or for its premature opening.

D. Submission and Opening of Bids

19) Deadline for Submission of Bids

Bids must be received by the Procuring Entity’s BAC at the address indicated in the **Invitation to Bid**, or through the e-bidding facility of the PhilGEPS, on or before the date and time indicated in the **BDS**.

20) Late Bids

Bids, including the eligibility requirements, submitted after the deadline shall be rejected by the BAC. The BAC shall record in the Minutes of the Meeting the submission and opening of bids, the Bidder’s name, its representative, and the time the late bid was submitted.

21) Modification and Withdrawal of Bids

21.1 Bidders may modify their bids before the deadline for the submission and receipt of bids.

- a) For manual submission and receipt of bids, the Bidders shall not be allowed to retrieve their original bid, but shall only be allowed to submit the bid modification by sending another bid, equally sealed, properly identified, linked to its original bid, and marked as a “modification,” thereof, and stamped “received” by the BAC. Bid modifications received after the applicable deadline shall not be considered and shall be returned to the bidder unopened.
- b) For online submission of bids, the Bidders shall not be allowed to retrieve their original Bid, but shall only be allowed to submit the bid modification, send another Bid equally secured, properly identified labelled as a “modification” of the one previously submitted. The time indicated in the latest bid receipt page generated shall be the official time of submission. Bids modification submitted after the applicable deadline shall not be accepted.

21.2 Bidders may withdraw their bids in writing before the deadline for submission and receipt of bids. Withdrawal of bids after the applicable deadline shall be subject to appropriate sanctions as prescribed in the IRR.

Bidders may also express their intention not to participate in the bidding in writing, which should be received by the BAC before the deadline for submission and receipt of bids. Bidders that withdraw their bids shall no longer be allowed to submit another bid for the same contract, directly or indirectly.

- 21.3 No bid may be modified after the deadline for submission and receipt of bids. Further, no bid may be withdrawn in the interval between the deadline for submission and receipt of bids, and the expiration of bid validity specified by the Bidder in the Financial Bid Form. Withdrawal of bid during this interval shall result in the forfeiture of the Bidder's Bid Security pursuant to **ITB** Clause 16.5, and the imposition of administrative sanctions as prescribed by RA No. 12009 and without prejudice to the imposition of civil and criminal sanctions as provided under applicable laws.

Alternative Bids shall be rejected. For this purpose, Alternative Bid shall pertain to an offer made by a bidder in addition or as a substitute to its original bid, which may be included as part of its original bid or submitted separately. A bid with options shall likewise be considered an Alternative Bid regardless of whether said bid proposal is contained in a single envelope or submitted in two (2) or more separate bid envelopes.

Bidders shall submit offers that comply with the requirements of the Bidding Documents, including the basic technical design as indicated in the drawings and specifications. Unless there is a value engineering clause in the **BDS**, alternative bids shall not be accepted.

Each Bidder shall submit only one Bid, either individually or as a partner in a JV. A Bidder who submits or participates in more than one bid (other than as a subcontractor if a subcontractor is permitted to participate in more than one bid) will cause all the proposals with the Bidder's participation to be disqualified. This shall be without prejudice to any applicable criminal, civil and administrative penalties that may be imposed upon the persons and entities concerned.

22) Opening and Preliminary Examination of Bids

- 22.1 The BAC shall open the bids in public, immediately after the deadline for submission and receipt of bids, as specified in the **BDS**. In case the Bids cannot be opened as scheduled due to justifiable reasons, the BAC shall take custody of the submitted Bids and reschedule the opening of Bids on the next working day or at the soonest possible time, through the issuance of a Notice of Postponement to be posted on the PhilGEPS website and the website of the Procuring Entity concerned.
- 22.2 The manner of opening of the bids for Infrastructure Projects shall depend on the award criterion to be adopted, as follows:
- a) For LCRB and MEARB, the BAC shall open the technical and financial proposals on the same day; and
 - b) For MARB, only the technical proposals shall be opened while the financial proposals shall remain unopened and shall be kept securely by the BAC until the specified time of their opening as indicated in the **BDS**. Only the financial proposals of the bidders who have met the highest technical score for MAB shall be opened.
- 22.3 The Procuring Entity shall prepare the minutes of the proceedings of the bid opening that shall include, as a minimum: (a) names of Bidders, their bid price (per lot, if applicable, and/or including discount, if any), bid security, findings of preliminary

examination, and whether there is a withdrawal or modification; and (b) attendance sheet. The BAC members shall sign the abstract of bids as read.

22.4 The Bidders or their duly authorized representatives may attend the opening of bids. The BAC shall ensure the integrity, security, and confidentiality of all submitted bids. The Abstract of bids, as read, and the minutes of the bid opening shall be made available to the public, upon written request and payment of a specified fee to recover the cost of materials.

22.5 To ensure transparency and accurate representation of the bid submission, the BAC Secretariat shall notify in writing all bidders whose bids it has received through mail at its PhilGEPS-registered physical address or official e-mail address. The said notice shall be issued within seven (7) calendar days from the date of the bid opening.

E. Evaluation and Comparison of Bids

23) Process to be Confidential

23.1 Members of the BAC, its staff and personnel, Secretariat, and TWG, as well as Observers, are prohibited from making or accepting any communication with any bidder regarding the evaluation of their bids until the issuance of the Notice of Award, unless otherwise allowed in the case of **ITB** Clause 24.

23.2 Any effort by a Bidder to influence the Procuring Entity in the Procuring Entity's decision in respect of bid evaluation, bid comparison or contract award will result in the rejection of the bid.

24) Clarification of Bids

To assist in the evaluation, comparison, and post-qualification of the bids, the Procuring Entity may ask in writing any Bidder for a clarification of its bid. All responses to requests for clarification shall be in writing. Any clarification submitted by a Bidder in respect to its bid that is not in response to the request of the Procuring Entity shall not be considered.

25) Detailed Evaluation and Comparison of Bids

25.1 The Procuring Entity's evaluation of bids shall be based on the bid price quoted in the Bid Form, which includes the Bill of Quantities.

25.2 The Procuring Entity will undertake the detailed evaluation and comparison of the bids which have passed the opening and preliminary examination of bids, pursuant to **ITB** Clause 22, to determine the Lowest Calculated Bid (LCB), Most Economically Advantageous Bid (MEAB), and Most Advantageous Bid (MAB).

25.3 The award criterion shall be determined as follows:

a) For LCB:

- i) The detailed evaluation of the financial component of the bids, to establish the correct calculated prices of the bids; and
- ii) The ranking of the total bid prices as so calculated from the lowest to highest, where the bid with the lowest price shall be identified as the LCB.

- b) For MEAB, the BAC shall evaluate the quality and price proposals to determine the MEAB using the following steps:
- i) The quality proposal together with the price proposal shall be considered in the evaluation of bids. The quality proposals shall be evaluated first using the criteria in the **BDS**. The price proposals of the bids that meet the minimum quality score shall then be opened.
 - ii) The price and quality proposals shall be given corresponding weights with the price proposal given a minimum weight of fifteen percent (15%) up to a maximum of forty percent (40%). The weight of the quality criteria shall be adjusted accordingly such that their total weight in percent together with the weight given to the price proposal shall be equal to one hundred percent (100%).
 - iii) To further promote green public procurement, the sustainability of materials or structures with green specifications shall be given greater weight in the evaluation of bids. As approved by the BAC, the exact weights shall be indicated in the **BDS**. The BAC shall rank the bidders in descending order based on the combined numerical ratings of their quality and price proposals. The bidder with the best overall score using the quality-price ratio shall be referred to as the MEAB.
 - iv) The HoPE shall approve or disapprove the recommendations of the BAC within two (2) calendar days after receipt of the results of the evaluation from the BAC.

The quality component shall be assessed on the basis of criteria with corresponding numerical weights indicated in the **BDS**, which may include qualitative, environmental, or social aspects linked to the subject matter of the contract. These may include any or a combination of the following:

- a) Quality and technical merit, including technical competence and a credible track record;
 - b) Aesthetic and functional design and characteristics;
 - c) Approach and methodology;
 - d) Accessibility;
 - e) Tools and equipment;
 - f) Social, environmental, economic, and innovative characteristics;
 - g) Organization, qualification, and experience of employees or staff assigned to perform the contract;
 - h) Ongoing contracts and work commitments; or
 - i) Other relevant criteria in relation to the subject Infrastructure Projects to be procured.
- c) For MAB

- i) The BAC shall evaluate the quality proposals to determine the MAB using the quality components. The quality components shall be assessed on the basis of the criteria with corresponding numerical weights indicated in the **BDS** to determine the bidder with the highest technical rating.
 - ii) The second bid envelope of the bidder obtaining the highest technical rating shall be opened. If the financial proposal is equal to or lower than the ABC, the bid shall be accepted and determined as the MAB; otherwise, the same shall be rejected and the bidder will be disqualified.
- 25.4 In order to eliminate bias in evaluating the quality proposals, it is recommended that the highest and lowest scores for each bidder for each criterion shall not be considered in determining the average scores of the bidders, except when the evaluation is conducted in a collegial manner.
- 25.5 The BAC shall immediately conduct a detailed evaluation of all bids using non-discretionary criteria in considering the following:
- a) Completeness of the bid. Unless the **BDS** allows partial bids, bids not addressing or providing all of the required items in the BDS shall be considered non-responsive and, thus, automatically disqualified.

However, when no price or a zero (0) or a dash (-) is indicated in a required item in the bid form, the same shall be construed that it is being offered for free to the Government, except those required by law or regulations to be provided for; and
 - b) Arithmetical corrections. The BAC shall consider computational errors and omissions to enable proper comparison of all eligible bids. It may also consider bid correction if expressly allowed in the **BDS**. Any adjustment shall be calculated in monetary terms to determine the calculated prices.
- 25.6 Based on the detailed evaluation of bids, those that comply with the above-mentioned requirements shall be ranked in the ascending order of their total calculated bid prices, as evaluated and corrected for computational errors, discounts and other modifications, to identify the LCB, MEAB, or MAB. Total calculated bid prices, as evaluated and corrected for computational errors, discounts and other modifications, which exceed the ABC shall not be considered, unless otherwise indicated in the **BDS**.
- 25.7 The BAC shall evaluate all bids on an equal footing to ensure fair and competitive bid comparison. For this purpose, all bidders shall be required to include in their bids the cost of all taxes, such as, but not limited to, value-added tax (VAT), income tax, local taxes, and other fiscal levies and duties. Such bids, including said taxes, shall be the basis for the bid evaluation and comparison.
- 25.8 If so indicated pursuant to **ITB** Clause 1.1, bids may be submitted for individual lots, or for any combination thereof, provided that all bids and combinations of bids shall be received by the same deadline and opened and evaluated simultaneously so as to determine the bid or combination of bids offering the lowest calculated cost to the Procuring Entity. Bid prices quoted shall correspond to all of the requirements specified for each lot. Bid Security as required by **ITB** Clause 16 shall be submitted for each contract (lot) separately. The basis for evaluation of lots is specified in **BDS** Clause 25.5 (a).

26) Post - Qualification

- 26.1 The BAC shall determine to its satisfaction whether the Bidder that is evaluated as having submitted the LCB, MEAB, or MAB, as the case may be, complies with and is responsive to all the requirements and conditions specified in **ITB** Clauses 5 and 12. The Bidder, within a non-extendible period of five (5) calendar days from receipt of notice from the BAC that it submitted the LCB, MEAB, or MAB, shall submit all the eligibility documents supporting its PhilGEPS Certificate of Registration (Platinum Membership), its latest income and business tax returns filed for the preceding quarter which should not be earlier than two (2) quarters from the date of submission and receipt of bid, and other appropriate licenses and permits required by law and stated in the **BDS**.
- 26.2 Failure to submit any of the post-qualification requirements on time, or a finding against the veracity thereof, shall disqualify the Bidder for award; Provided, That in the event that a finding against the veracity of any of the documents submitted is made, it shall cause the forfeiture of the Bid Security.
- 26.3 The determination shall be based upon an examination of the documentary evidence of the Bidder's qualifications submitted pursuant to **ITB** Clause 12, as well as other information as the Procuring Entity deems necessary and appropriate, using a non-discretionary "pass/fail" criterion, which shall be completed within a period of twelve (12) calendar days.
- 26.4 If the BAC determines that the bidder with the LCB, MEAB, or MAB passes all the criteria for post-qualification, it shall declare the said bid as the LCRB, MEARB, MARB, SCB, SEAB, or Single Advantageous Bid (SAB) and recommend to the HoPE the award of contract to the said bidder at its submitted bid price or its calculated bid price, whichever is lower or, in the case of quality-based evaluation procedure, submitted bid price or its negotiated price, whichever is lower.
- If, however, the BAC determines that the bidder with the LCB, MEAB, MAB, SCB, SEAB, or SAB fails to meet the post-qualification criteria, it shall immediately notify the Bidder in writing of its post-disqualification and the grounds for such determination.⁵
- 26.5 Immediately after the BAC has notified the first bidder of its post-disqualification, and notwithstanding any pending request for reconsideration thereof, the BAC shall initiate and complete the same post-qualification process on the bidder with the second LCB, MEAB, or MAB. If the second bidder passes the post-qualification and provided that the request for reconsideration of the first bidder has been denied, the second bidder shall be post-qualified as the bidder with the LCB, MEAB, or MAB.
- 26.6 If the second bidder, however, fails the post-qualification, the procedure for post-qualification shall be repeated for the bidder with the next LCB, MEAB, or MAB and so on, until the LCRB, MEARB, or MARB, as the case may be, is determined for award, subject to the procedure of Notice and Execution of Award.
- 26.7 Within a period not exceeding ten (10) calendar days from the determination by the BAC of the LCRB, MEARB, MARB, SCRB, SEARB, or SARB and the recommendation to award the contract, the HoPE or its duly authorized representative shall approve or disapprove the said recommendation.

⁵ Sec 63.5 of the IRR.

- 26.8 In case of approval, the HoPE or its duly authorized representative shall immediately issue the Notice of Award to the bidder with the LCRB, MEARB, MARB, SCRB, SEARB, or SARB, as the case may be.

In the event that the approving authority shall disapprove the resolution on the award of the contract, such disapproval shall be based only on valid, reasonable, and justifiable grounds as enumerated under Section 70 of the IRR to be expressed in writing. A copy of the decision disapproving the resolution shall be furnished to the BAC and the bidder.

27) Reservation Clause

- 27.1 Notwithstanding the eligibility or post-qualification of a bidder and without incurring any liability, the HoPE or its duly authorized representative at any stage of the procurement, reserves the right to review its qualifications, reject any and all bids, declare a failure of bidding or not award the contract in the following situations:

- a) If it has reasonable grounds to believe that a misrepresentation has been made by the said bidder; or
- b) If it has reasonable grounds to believe that there has been a change in the bidder's capability to undertake the project from the time it submitted its eligibility requirements.

Should such review uncover any misrepresentation made in the eligibility and bidding requirements, statements or documents, or any changes in the situation of the Bidder which will adversely affect its capability to undertake the Project so that it no longer meets the prescribed eligibility or bid evaluation criteria, the Procuring Entity shall consider the said Bidder as ineligible and disqualify it from participating further in the bidding process or being awarded the contract.

- 27.2 Based on the following grounds, the HoPE or its duly authorized representative reserves the right to reject any and all Bids, declare a Failure of Bidding at any time prior to the contract award, or not to award the contract, without thereby incurring any liability, and make no assurance that a contract shall be entered into as a result of the bidding:

- a) If there is *prima facie* evidence of collusion between appropriate public officers or employees of the Procuring Entity, or between the BAC and any of the bidders, or if the collusion is between or among the bidders themselves, or between a bidder and a third party, including any act which restricts, suppresses or nullifies or tends to restrict, suppress or nullify competition or influences or tends to influence the bidding process;
- b) If the BAC is found to have failed in complying with the applicable law or in following the prescribed bidding procedures; or
- c) If there are any justifiable and reasonable ground where the award of the contract will not redound to the benefit of the government, in instances where (i) the physical and economic conditions have significantly changed so as to render the project no longer economically, financially or technically feasible as determined by the HoPE; (ii) the Project is no longer necessary as determined by the HoPE; and (iii) the source of funds for the Project has been withheld or reduced through no fault of the Procuring Entity.

F. Award of Contract

28) Contract Award

- 28.1 Subject to **ITB** Clause 26, the HoPE or its duly authorized representative shall award the contract to the Bidder whose bid has been determined to be the LCRB, MEARB, MARB, SCRB, SEARB, or SARB, as the case may be.
- 28.2 Prior to the expiration of the period of bid validity, the Procuring Entity shall notify the winning Bidder in writing that its bid has been accepted, through a Notice of Award duly received by the Bidder or its representative personally or by registered mail or electronically, receipt of which must be confirmed in writing within two (2) days by the Bidder with the LCRB, MEARB, MARB, SCRB, SEARB, or SARB, as applicable, and submitted personally or sent by registered mail or electronically to the Procuring Entity.
- 28.3 Within ten (10) calendar days from receipt by the winning bidder of the Notice of Award, the following conditions should be complied with before the contract may be awarded:
- a) Submission of the following documents:
 - i) Valid JVA, if applicable;
 - ii) The SEC Certificate of Registration of the foreign corporation, if applicable; or
 - iii) Valid PCAB license and registration for the type and cost of the Project for foreign bidders when the Treaty or International or Executive Agreement expressly allows submission of such license and registration as a pre-condition to the Notice of Award.
 - b) Posting of the performance security in accordance with **ITB** Clause 30; and
 - c) Signing of the contract as provided in **ITB** Clause 29.

29) Signing of the Contract

- 29.1 Within ten (10) calendar days from receipt of the Notice of Award, the winning Bidder shall post the required performance security, sign and date the contract, and return it to the Procuring Entity.
- 29.2 The Procuring Entity shall enter into a contract with the successful Bidder within the same ten (10) calendar day period provided that all the documentary requirements are complied with.
- 29.3 The following documents shall form part of the contract:

- a) Contract Agreement;
- b) Bidding Documents;
- c) Winning Bidder's bid, including the technical and financial proposals, and all other documents/statements submitted (e.g., Bidder's response to request for clarifications on the bid), including corrections to the bid, if any, resulting from the Procuring Entity's bid evaluation;
- d) Performance Security;
- e) Notice of Award of Contract; and
- f) Other contract documents that may be required by existing laws and/or specified in the **BDS**.

30) Performance Security

- 30.1 To guarantee the faithful performance by the winning bidder of its obligations under the contract, it shall post a performance security prior to the signing of the contract. Furthermore, the successful bidder shall be required to update the performance security posted before to the issuance of a variation order, if any.
- 30.2 Sectors enumerated under Section 76.1⁶ of the IRR may be allowed to post Performance Securing Declaration (PSD) as specified in the **BDS**.
- 30.3 The performance security shall be in a form selected by the Procuring Entity in the amount indicated in the **BDS**, which shall not be less than the percentage of the total contract price in accordance with the following price schedule:

Form of Performance Security	Amount of Performance Security (Not less than the Percentage of the Total Contract Price)
a) Cash or Cashier's or Manager's check issued by a bank. <i>For biddings conducted by LGUs, the cashier's or manager's check may be issued by other banks certified by the BSP</i>	

⁶ Section 76.1. The GPPB, once data is available from relevant agencies, shall maintain a registry of entities belonging to the following sectors:

- a) Farmers as certified by the Department of Agriculture (DA);
- b) Fisherfolk as certified by the Bureau of Fisheries and Aquatic Resources (BFAR);
- c) Persons with disabilities as certified by the National Council for Disability Affairs (NCDA) pursuant to RA No. 7277, otherwise known as the Magna Carta for Disabled Persons, as amended;
- d) Solo parents as certified by the Department of Social Welfare and Development (DSWD); e) Microenterprises and social enterprises as certified by the MSMED Council;
- f) Startups, spin-offs, and other forms of entity involved in science, technology, and innovation activities as certified by the DTI, DICT, NIC or the Department of Science and Technology (DOST), as may be applicable;
- g) Cooperatives duly registered with the CDA pursuant to RA No. 6938, otherwise known as the Cooperative Code of the Philippines, as amended; and
- h) Other relevant sectors as may be determined by the GPPB to ensure inclusivity and diversity in the procurement process.

<i>as authorized to issue such financial instrument.</i>	Ten percent (10%)
b) Bank draft or guarantee or irrevocable Letter of Credit issued by a local bank. If issued by a foreign bank, it shall be confirmed or authenticated by a local bank.	
c) Surety bond callable upon demand issued by a surety or insurance company duly certified by the IC as authorized to issue such security.	Thirty Percent (30%)

30.4 The performance security shall be denominated in Philippine Peso and posted in favor of the Procuring Entity, which shall be forfeited in the event it is established that the winning bidder is in default in any of its obligations under the contract.

31) Notice to Proceed

The Procuring Entity shall issue the Notice to Proceed to the winning Bidder not later than three (3) calendar days from the date of approval of the contract by the appropriate signatories. All notices called for by the terms of the contract shall be effective only at the time of receipt thereof by the successful Bidder.

32) Protest Mechanism

Decisions of the BAC in all stages of procurement may be protested to the HoPE in accordance with Section 83 of the IRR.

Section III. Bid Data Sheet

Bid Data Sheet

ITB Clause	
1.1	<p>The Procuring Entity is Provincial Government of Camarines Norte</p> <p>The Project title is Extension of Covered Court and Flooring, P-4, Brgy. Mampurog, San Lorenzo Ruiz, Camarines Norte.</p> <p>The identification number of the Contract is ITB-2026-032.</p>
2	<p>The Funding Source is:</p> <p>2.1 The GOP through the source of funding as indicated below for 20% Development Fund CY2026 in the amount of Two Million One Hundred Eighteen Thousand Three Hundred Ninety-Six Pesos and Sixty-Six Centavos (P2,118,396.66).</p> <p>2.2 The source of funding is:</p> <p style="padding-left: 40px;">a. LGUs, the proposed Local Expenditure Program.</p>
3.1	No further instructions.
5.2	Bidding is restricted to eligible bidders as defined in ITB Clause 5.2.
5.4	<p>Contracts similar to the Project shall be those described as follows:</p> <p>Building Construction</p>

7	No further instructions.																		
8.1	<i>“Subcontracting is not allowed.”</i>																		
8.3	<i>“Not applicable.”</i>																		
9.1	Pre-Bid Conference is not required.																		
10.1	<p>The Procuring Entity’s address is:</p> <p><i>2nd Floor, BAC Office</i> <i>Provincial Capitol Bldg., Daet, Camarines Norte</i></p> <p>ENGR. ALMIRANTE A. ABAD <i>Head, BAC Secretariat</i> <i>(054) 885-1474</i></p>																		
12.1(h)(ii)	<p>The minimum work experience requirements for key personnel are the following:</p> <table border="0"> <thead> <tr> <th><u>Key Personnel</u></th> <th><u>General Experience</u></th> <th><u>Relevant Experience</u></th> </tr> </thead> <tbody> <tr> <td>Project Manager</td> <td>one (1)</td> <td>one (1)</td> </tr> <tr> <td>Project Engineer</td> <td>one (1)</td> <td>one (1)</td> </tr> <tr> <td>Materials Engineer</td> <td>one (1)</td> <td>one (1)</td> </tr> <tr> <td>Safety Officer</td> <td>one (1)</td> <td>one (1)</td> </tr> <tr> <td>Construction Foreman</td> <td>one (1)</td> <td>one (1)</td> </tr> </tbody> </table>	<u>Key Personnel</u>	<u>General Experience</u>	<u>Relevant Experience</u>	Project Manager	one (1)	one (1)	Project Engineer	one (1)	one (1)	Materials Engineer	one (1)	one (1)	Safety Officer	one (1)	one (1)	Construction Foreman	one (1)	one (1)
<u>Key Personnel</u>	<u>General Experience</u>	<u>Relevant Experience</u>																	
Project Manager	one (1)	one (1)																	
Project Engineer	one (1)	one (1)																	
Materials Engineer	one (1)	one (1)																	
Safety Officer	one (1)	one (1)																	
Construction Foreman	one (1)	one (1)																	

12.1(h)(iii)	<p>The minimum major equipment requirements are the following:</p> <table border="1"> <thead> <tr> <th data-bbox="411 443 794 479"><u>Equipment</u></th> <th data-bbox="842 443 1034 479"><u>Capacity</u></th> <th data-bbox="1098 443 1299 479"><u>Number of Units</u></th> </tr> </thead> <tbody> <tr> <td data-bbox="459 510 794 546">1. 4x4 Pickup Type vehicle</td> <td data-bbox="842 510 1034 546"></td> <td data-bbox="1209 510 1235 546">1</td> </tr> <tr> <td data-bbox="459 577 794 613">2. Concrete Mixer</td> <td data-bbox="842 577 1034 613">One (1) Bagger</td> <td data-bbox="1209 577 1235 613">1</td> </tr> <tr> <td data-bbox="459 645 794 680">3. Concrete Vibrator</td> <td data-bbox="842 645 1034 680"></td> <td data-bbox="1209 645 1235 680">1</td> </tr> <tr> <td data-bbox="459 712 794 748">4. Welding Machine</td> <td data-bbox="842 712 1034 748"></td> <td data-bbox="1209 712 1235 748">1</td> </tr> <tr> <td data-bbox="459 779 794 815">5. Hoisting Machine</td> <td data-bbox="842 779 1034 815"></td> <td data-bbox="1209 779 1235 815">1</td> </tr> </tbody> </table>	<u>Equipment</u>	<u>Capacity</u>	<u>Number of Units</u>	1. 4x4 Pickup Type vehicle		1	2. Concrete Mixer	One (1) Bagger	1	3. Concrete Vibrator		1	4. Welding Machine		1	5. Hoisting Machine		1
<u>Equipment</u>	<u>Capacity</u>	<u>Number of Units</u>																	
1. 4x4 Pickup Type vehicle		1																	
2. Concrete Mixer	One (1) Bagger	1																	
3. Concrete Vibrator		1																	
4. Welding Machine		1																	
5. Hoisting Machine		1																	
12.4	<p>The ABC is Two Million One Hundred Eighteen Thousand Three Hundred Ninety-Six Pesos and Sixty-Six Centavos (P2,118,396.66). Any bid with a financial component exceeding this amount shall not be accepted.</p>																		
14.1	<p>The bid prices shall be quoted in Philippine Peso.</p>																		

14.3	Payment shall be made in Philippine Peso.
15.1	Bids will be valid for <i>120 days</i> from bid opening.
16.1	<p>The Bid Security shall be in the form of a Bid Securing Declaration, and choose at least two (2) from any of the following:</p> <ol style="list-style-type: none"> 1. The amount of not less than 2% of ABC, if bid security is in cash. 2. The amount of not less than 2% of ABC, if bid security is in cashier's check. 3. The amount of not less than 2% of ABC, if bid security is in manager's check. 4. The amount of not less than 5% of ABC, if bid security is in bank draft. 5. The amount of not less than 5% of ABC, if bid security is in guarantee. 6. The amount of not less than 5% of ABC, if irrevocable Letter of Credit. 7. The amount of not less than 5% of ABC, if Surety Bond.
16.2	The Bid Security shall be valid until <i>120 days from opening of bid</i> .
16.3	<p>In case of extension of bid validity and bid security validity period, Substitution of the bid security form is allowed. Bid Securing Declaration and the following forms may be used:</p> <ol style="list-style-type: none"> a) Cash or Cashier's or Manager's Check issued by a Bank. b) Bank draft/guarantee or irrevocable Letter of Credit issued by a Bank: Provided, however, that it shall be confirmed or authenticated by a local Bank, if issued by a foreign bank. c) Surety bond callable upon demand issued by a surety or insurance company duly certified by the Insurance Commission as authorized to issue such security.
19	<p>The address for submission of bids is at 2nd Floor, BAC Office, Provincial Capitol Bldg., Daet, Camarines Norte</p> <p>The deadline for submission of bids is on or before February 10, 2026, at 1:30 p.m..</p>
21.5	"No further instructions."
22.1	<p>The date and time of bid opening is on February 10, 2026, 2:00 p.m. onwards.</p> <p>The place of bid opening is at 2nd Floor, BAC Office, Provincial Capitol Bldg., Daet, Camarines Norte</p>

22.2(b)	"Not applicable".
25.3 (c)(i)	"Not applicable"
25.5 (a)	<p>Partial bid is not allowed. The infrastructure project is packaged in a single lot and the lot shall not be divided into sub-lots for the purpose of bidding, evaluation, and contract award.</p> <p>In all cases, the NFCC computation, if applicable, must be sufficient for all the lots or contracts to be awarded to the Bidder.</p>
25.5 (b)	Bid correction is not allowed.
25.6	No further instructions.
26	<p>For purposes of Post-qualification, the following document(s) shall be required to be submitted/presented within five (5) calendar days from receipt of notice of post-qualification from the BAC:</p> <ol style="list-style-type: none"> 1. Income Tax Returns for year 2021 (BIR Form 1701 or 1702); 2. Latest Value Added Tax Returns (Forms 2550M and 2550Q) or Percentage Tax Returns (Form 2551M) for the last six (6) months before the deadline of the submission of bids. The income tax and business tax returns stated above should have been filed through the Electronic Filing and Payment System (eFPS). 3. Updated Certificate of accomplishments signed by the Owner or Owner's Project Engineer for on-going projects
29.3(f)	<ol style="list-style-type: none"> 1. The documents required in Section 66.5 of the IRR of R.A. 12009 shall form part of the Contract. 2. Additional contract documents relevant to the Project that may be required by existing laws and/or the Procuring Entity, such construction schedule, S-curve, and PERT-CPM, manpower schedule, construction methods, equipment utilization schedule, construction safety and health (CSH) program approved by the DOLE, and other acceptable tools of project scheduling. 3. Preliminary conceptual design plans in accordance with the degree of details specified by the procuring entity; 4. Design and construction methods; and

	<p>5. Value engineering analysis of design and construction methods</p> <p>6. Program of Work showing the general methods, arrangements, order, and timing for all activities in the work.</p>
30.2	“Not applicable”
30.3	<p>The Performance Security shall be in the form: <i>[choose one from any of the following:]</i></p> <ol style="list-style-type: none"> 1) The amount of not less than 10% of the contract price, if performance security is in cash. 2) The amount of not less than 10% of the contract price, if performance security is in cashier’s check. 3) The amount of not less than 10% of the contract price, if performance security is in manager’s check. 4) The amount of not less than 10% of the contract price, if performance security is in bank draft. 5) The amount of not less than 10% of the contract price, if performance security is in guarantee. 6) The amount of not less than 10% of the contract price, if performance security is irrevocable LoC. Or 7) The amount of not less than 30% of the contract price, if performance security is Surety Bond.

Section IV. General Conditions of Contract

TABLE OF CONTENTS

1. General Terms	52
2. Interpretation.....	52
3. Governing Language and Law	53
4. Communications	53
5. Possession of Site.....	53
6. The Contractor's Obligations	53
7. Subcontracting	54
8. Advance Payment.....	55
9. Progress Payments	56
10. Payment Documents.....	57
11. Retention	57
12. Performance Security	58
13. Detailed Engineering and Site Investigation Reports	59
14. Licenses and Permits.....	60
15. Contractor's Risk and Warranty Security	60
16. Procuring Entity's Risk	62
17. Insurance.....	63
18. Liquidated Damages	64
19. Settlement of Disputes.....	64
20. Liability of the Contractor.....	65
21. Termination for Breach of Contract	65
22. Termination Due to Force Majeure.....	66
23. Termination by Contractor	66
24. Termination for Convenience	67
25. Termination for Unlawful Acts.....	667
26. Termination for Other Causes.....	667
27. Procedures for Termination of Contracts	68
28. Approval of Drawings and Temporary Works by the Procuring Entity	69
29. Acceleration and Delays Ordered by the Procuring Entity	70
30. Contractor's Right to Claim	70
31. Dayworks.....	70
32. Early Warning	70

33. Program of Work.....	70
34. Management Conferences.....	71
35. Bill of Quantities	71
36. Instructions, Inspections and Audits	72
37. Identifying Defects	72
38. Correction of Defects	72
39. Uncorrected Defects	72
40. Variation Orders.....	72
41. Contract Completion	74
42. Suspension of Work	74
43. Payment on Termination	75
44. Extension of Contract Time	75
45. Price Escalation.....	76
46. Completion.....	76
47. Taking Over	77
48. Operating and Maintenance Manuals	77

1) General Terms

In this Contract, the following terms shall be interpreted as indicated:

- 1.1 The **Intended Completion Date** refers to the date specified in the **SCC** when the Contractor is expected to have completed the Works. The intended Completion Date may be revised only by the Procuring Entity by issuing an extension of time or an acceleration order.
- 1.2 The **Procuring Entity** is the party who employs the Contractor to carry out the Works stated in the **SCC**.
- 1.3 The **Site** is the place provided by the Procuring Entity where the Works shall be executed and any other place or places which may be designated in the **SCC**, or notified to the Contractor by the Procuring Entity as forming part of the Site.
- 1.4 The **Start Date**, as specified in the **SCC**, is the date when the Contractor is obliged to commence execution of the Works. It does not necessarily coincide with any of the Site Possession Dates.
- 1.5 **Work(s)** refer to the Permanent Works and Temporary Works to be executed by the Contractor in accordance with this Contract, including (i) the furnishing of all labor, materials, equipment and others incidental, necessary or convenient to the complete execution of the Works; (ii) the passing of any tests before acceptance by the Procuring Entity; (iii) and the carrying out of all duties and obligations of the Contractor imposed by this Contract as described in the **SCC**. In line with this, Temporary Works are works designed, constructed, and installed by the Contractor that are needed for construction or installation of the Permanent Works, which are subsequently removed.

2) Interpretation

- 2.1 In interpreting the Conditions of Contract, singular also means plural, male also means female or neuter, and the other way around. Headings have no significance. Words have their normal meaning under the language of this Contract unless specifically defined. The Procuring Entity will provide instructions clarifying queries about the Conditions of Contract.
- 2.2 If sectional completion is specified in the **SCC**, references in the Conditions of Contract to the Works, the Completion Date, and the Intended Completion Date apply to any Section of the Works (other than references to the Completion Date and Intended Completion Date for the whole of the Works).
- 2.3 The documents forming this Contract shall be interpreted in the following order of priority:
 - a) Contract Agreement;
 - b) Bid Data Sheet;
 - c) Instructions to Bidders;
 - d) Addenda to the Bidding Documents;
 - e) Special Conditions of Contract;

- f) General Conditions of Contract;
- g) Specifications;
- h) Bill of Quantities; and
- i) Drawings.

3) Governing Language and Law

- 3.1 This Contract shall be interpreted in accordance with the laws of the Republic of the Philippines.
- 3.2 This Contract has been executed in the English language, which shall be the binding and controlling language for all matters relating to the meaning or interpretation of this Contract. All correspondence and other documents pertaining to this Contract which are exchanged by the parties shall be written in English.

4) Communications

Communications between parties that are referred to in the Conditions shall be effective only if made in writing. A notice shall be effective only when it is received by the concerned party.

5) Possession of Site

- 5.1 On the date specified in the **SCC**, the Procuring Entity shall grant the Contractor possession of so much of the Site as may be required to enable it to proceed with the execution of the Works. If the Contractor suffers delay or incurs cost from failure on the part of the Procuring Entity to give possession in accordance with the terms of this clause, the Procuring Entity shall give the Contractor a Contract Time Extension and certify such sum as fair to cover the cost incurred, which sum shall be paid by Procuring Entity.
- 5.2 If possession of a portion is not given by the date stated in the **SCC** Clause 1.3, the Procuring Entity will be deemed to have delayed the start of the relevant activities. The resulting adjustments in contract time to address such delay shall be in accordance with **GCC** Clause 44.
- 5.3 The Contractor shall bear all costs and charges for special or temporary right-of-way required by it in connection with access to the Site. The Contractor shall also provide at its own cost any additional facilities outside the Site required by it for purposes of the Works.
- 5.4 The Contractor shall allow the Procuring Entity and any person authorized by the Procuring Entity access to the Site and to any place where work in connection with this Contract is being carried out or is intended to be carried out.

6) The Contractor's Obligations

- 6.1 The Contractor shall carry out the Works properly and in accordance with this Contract. The Contractor shall provide all supervision, labor, Materials, Plant and Contractor's Equipment, which may be required. All Materials and Plant on Site shall be deemed to be the property of the Procuring Entity.

- 6.2 The Contractor shall commence execution of the Works on the Start Date and shall carry out the Works in accordance with the Program of Work submitted by the Contractor, as updated with the approval of the Procuring Entity, and complete them by the Intended Completion Date.
- 6.3 The Contractor shall be responsible for the safety of all activities on the Site.
- 6.4 The Contractor shall carry out all instructions of the Procuring Entity that comply with the applicable laws where the Site is located.
- 6.5 The Contractor shall employ the key personnel named in the Schedule of Key Personnel, as referred to in the **SCC**, to carry out the supervision of the Works. The Procuring Entity will approve any proposed replacement of key personnel only if their relevant qualifications and abilities are equal to or better than those of the personnel listed in the Schedule.
- 6.6 If the Procuring Entity asks the Contractor to remove a member of the Contractor's staff or work force, for justifiable cause, the Contractor shall ensure that the person leaves the Site within seven (7) days and has no further connection with the Work in this Contract.
- 6.7 During Contract implementation, the Contractor and its subcontractors shall abide at all times by all labor laws, including child labor related enactments, and other relevant rules.
- 6.8 The Contractor shall submit to the Procuring Entity for consent the name and particulars of the person authorized to receive instructions on behalf of the Contractor.
- 6.9 The Contractor shall cooperate and share the Site with other contractors, public authorities, utilities, and the Procuring Entity between the dates given in the schedule of other contractors particularly when they shall require access to the Site. The Contractor shall also provide facilities and services for them during this period. The Procuring Entity may modify the schedule of other contractors, and shall notify the Contractor of any such modification thereto.
- 6.10 Should anything of historical or other interest or of significant value be unexpectedly discovered on the Site, it shall be the property of the Procuring Entity. The Contractor shall notify the Procuring Entity of such discoveries and carry out the Procuring Entity's instructions in dealing with them.

7) Subcontracting

- 7.1 Unless otherwise indicated in the **SCC**, the Contractor shall not subcontract portions of the Works beyond the percentage specified in **BDS** Clause 8.1. If subcontracting is allowed, the arrangement, including the timing for submission of the subcontractor's eligibility documents, shall be disclosed.
- 7.2 For subcontracting arrangements, the following rules shall apply for both locally-funded projects and to projects financed through Official Development Assistance, except those covered by treaty, or international, or executive agreements:
 - a) The subcontracted portion of the contract shall be subject to the approval of the HoPE and the following conditions:

- i) The subcontracted portion shall not exceed fifty percent (50%), or a different percentage on a per project basis as approved by the GPPB. The threshold percentages fixed herein shall be subject to the periodic review and adjustments as may be deemed appropriate by the GPPB; and
 - ii) The subcontracted portion shall be limited to components that are not deemed "significant or material" to the project as determined by the Procuring Entity.
- b) Subcontracting arrangement, if allowed, including the time of submission of the eligibility documents of the subcontractor, shall be disclosed in the Bidding Documents;
 - c) Subcontractors must meet the eligibility criteria and shall submit the same eligibility documents as the general contractor.

Failure of a subcontractor to meet the eligibility criteria does not affect the eligibility of the general contractor for the procurement project. In such case, the portion intended to be subcontracted to the ineligible subcontractor shall be assumed by the general contractor;

- d) The general contractor shall remain liable for the subcontractor's actions, defaults, delays, and negligence;
- e) The general contractor and the subcontractor are obliged to comply with the provisions of the contract and shall share liability, jointly and severally, in cases of violation of safety standards or other labor standards insofar as the subcontracted portion is concerned; and
- f) For purposes of post-qualification in accordance with its objective and process under the IRR, the value of the entire completed and accepted Project, including the subcontracted portion, shall be credited as experience of the general contractor. In the case of the subcontractor, the following rules shall apply:
 - i) The subcontractor shall get credit for one hundred percent (100%) of the value of the subcontracted portion of the project performed;
 - ii) Subcontractors shall be eligible to concessional windows of GFIs that treat receivables from the government as loan security; the receivables of subcontractors due from their general contractor shall similarly be accepted as loan security by GFIs; and
 - iii) Contract performance monitoring, such as the use of CPES, among others, shall also be mandatorily applied to the work experience of the subcontractors.

8) Advance Payment

- 8.1 The Procuring Entity shall make an advance payment on the Contract Price to the Contractor in an amount not exceeding fifteen percent (15%) of the total contract price to be made in lump sum or, at the most, two installments according to a schedule specified in the **SCC**.

- 8.2 The advance payment shall be made only upon:
- i) Written request of the contractor which shall form part of the contract document; and
 - ii) Submission of an irrevocable standby Letter of Credit of equivalent value from a bank as confirmed by the Procuring Entity; a bank guarantee; or a surety bond callable upon demand issued by a duly licensed surety or insurance company, at the option of the Procuring Entity.
- 8.3 The advance payment shall be recovered from the Contractor through deductions in amounts equivalent to the percentage of the total contract price that corresponds to the value of the advance payment granted.
- 8.4 Once a month, Contractors may submit documents, such as Monthly Certificates,⁷ to show the progress or partial completion of a project. The Contractor may reduce its standby letter of credit or guarantee instrument by the amounts refunded by the Monthly Certificates, or any equivalent document subject to auditing and accounting rules, in the advance payment.

9) Progress Payments

- 9.1 Once a month, the Contractor may submit a statement of work accomplished (SWA) or progress billing and corresponding request for progress payment for work accomplished. The SWA should show the amounts which the Contractor considers itself to be entitled to up to the end of the month, to cover (i) the cumulative value of the Works it executed to date, based on the items in the Bill of Quantities, and (ii) adjustments made for approved Variation Orders executed. Alternatively, the Procuring Entity may require in the Bidding Documents that the SWA or progress billing and the corresponding request for progress payment may only be submitted upon actual completion of the Infrastructure Project or a specific portion, segment, milestone or phase thereof.

The Procuring Entity or Project Engineer shall check the Contractor's SWA and certify the amount to be paid to the Contractor as progress payment. Materials and equipment delivered onsite but not yet incorporated in the Works shall not be included for payment, except as otherwise stipulated in the SCC.

- 9.2 The Procuring Entity shall deduct the following from the certified gross amounts to be paid to the Contractor as progress payment:
- a) Cumulative value of the work previously certified and paid for.
 - b) Portion of the advance payment to be recouped.
 - c) Retention money in accordance with the conditions of the contract.
 - d) Amount to cover third-party liabilities.
 - e) Amount to cover uncorrected discovered defects in the Works.

⁷ Commission on Audit (COA) Circular 2012-001.

- 9.3 Payments shall be adjusted by deducting therefrom the amounts for advance payments and retention. The Procuring Entity shall pay the Contractor the amounts certified by the Procuring Entity within twenty-eight (28) days from the date each certificate was issued. No payment of interest for delayed payments and adjustments shall be made by the Procuring Entity.
- 9.4 The first progress payment may be paid by the Procuring Entity to the Contractor, as indicated in the SCC; Provided, That at least a percentage of the Works has been accomplished as certified by the Procuring Entity and as indicated in the SCC.
- 9.5 Items of the Works for which a price of “0” (zero) has been entered will not be paid for by the Procuring Entity and shall be deemed covered by other rates and prices in the Contract.

10) Payment Documents

- 10.1 Subject to existing accounting and auditing rules and regulations,⁸ the Contractor shall submit to the Procuring Entity monthly statements of the estimated value of the work executed less the cumulative amount certified previously.
- 10.2 The Procuring Entity shall check the Contractor’s monthly statement and certify the amount to be paid to the Contractor.
- 10.3 The value of Work executed shall:
- a) be determined by the Procuring Entity;
 - b) comprise the value of the quantities of the items in the Bill of Quantities completed; and
 - c) include the valuations of approved variations.
- 10.4 The Procuring Entity may exclude any item certified in a previous certificate or reduce the proportion of any item previously certified in any certificate in the light of later information.

11) Retention

- 11.1 The Procuring Entity shall retain from each payment due to the Contractor an amount equal to a percentage thereof using the rate as specified in GCC Clause 11.2. The said amount will serve to guarantee indemnity for uncorrected discovered defects and third-party liabilities arising from this Contract. This retention money shall be utilized if the contractor fails to repair the discovered defects. Should the retention money be insufficient, the PE may forfeit the performance security, which may ultimately lead to the termination of the contract.⁹
- 11.2 Progress payments are subject to retention of ten percent (10%) referred to as the retention money. Such retention shall be based on the total amount due to the

⁸ COA Circular No. 2012-001.

⁹ Supreme Court rulings (e.g. New Bian Yek Commercial, Inc. vs. Office of the Ombudsman, et. al., GR No. 169338[2009], and Tondo Medical Center vs. Rante, G.R. No. 230645 [2019] have affirmed this purpose, stating that retention money is a form of security to ensure the satisfactory completion of works and to cover any defects or third-party claims that may arise after project completion.

Contractor prior to any deduction and shall be retained from every progress payment until fifty percent (50%) of the value of the Works, as determined by the Procuring Entity, are completed.

If, after fifty percent (50%) completion, the work is satisfactorily done and on schedule, no additional retention shall be made; otherwise, the ten percent (10%) retention shall be imposed, which may be decreased to 5 percent (5%) by the Procuring Entity based on justifiable causes.¹⁰

- 11.3 The total retention money shall be due for release upon final acceptance of the Works. The Contractor may, however, request the substitution of the retention money for each progress billing with irrevocable standby Letters of Credit from a bank, bank guarantees or surety bonds callable on demand, of amounts equivalent to the retention money substituted for and acceptable to Government; Provided, That the project is on schedule and is satisfactorily undertaken. Otherwise, the ten (10%) percent retention shall be made. Said irrevocable standby letters of credit, bank guarantees and/or surety bonds, to be posted in favor of the Government shall be valid for a duration to be determined by the concerned implementing office/agency or Procuring Entity and will answer for the purpose for which the ten (10%) percent retention is intended, *i.e.*, to cover uncorrected discovered defects and third party liabilities.
- 11.4 On completion of the whole Works, the Contractor may substitute retention money with an “on demand” Bank guarantee in a form acceptable to the Procuring Entity.

12) Performance Security

- 12.1 Within ten (10) calendar days from receipt of the Notice of Award from the Procuring Entity, but in no case later than the signing of the contract by both parties, the winning Contractor shall furnish the performance security in any of the forms prescribed in **ITB** Clause 30 in relation to **BDS** Clause 30.2 and 30.3.
- 12.2 The performance security posted in favor of the Procuring Entity shall be forfeited in the event it is established that the Contractor is in default in any of its obligations under the contract.
- 12.3 The performance security shall remain valid until issuance by the Procuring Entity of the Certificate of Final Acceptance. In case the performance security issued is valid for a specific period shorter than the term of the contract, including the defects liability period, the same shall be renewed or extended as often as necessary and immediately submitted to the Procuring Entity. In case of approved contract time extensions, the Contractor shall cause the extension of the validity of the performance security to cover the said extensions.
- 12.4 The performance security may be released by the Procuring Entity after the issuance of the Certificate of Final Acceptance; Provided, That the Procuring Entity has no claims filed against the performance security.
- 12.5 The Contractor shall post an additional performance security following the amount and form specified in **ITB** Clause 30 to cover any cumulative increase of more than ten

¹⁰ Section 71.2.8 of the IRR.

percent (10%) over the original value of the contract as a result of change orders, extra work orders and supplemental agreements, as the case may be.

- 12.6 In case of a reduction in the contract value or for partially completed Works under the contract which are usable and accepted by the Procuring Entity the use of which, in the judgment of the implementing agency or the Procuring Entity, will not affect the structural integrity of the entire project, the Procuring Entity shall allow a proportional reduction in the original performance security, provided that any such reduction is more than ten percent (10%) and that the aggregate of such reductions is not more than fifty percent (50%) of the original performance security.
- 12.7 Unless otherwise indicated in the **SCC**, the Contractor, by entering into the Contract with the Procuring Entity, acknowledges the right of the Procuring Entity to institute action pursuant to Act No. 3688¹¹ against any subcontractor be they an individual, firm, partnership, corporation, or association supplying the Contractor with labor, materials and/or equipment for the performance of this Contract.

13) Detailed Engineering and Site Investigation Reports

- 13.1 The Contractor, in preparing the Bid, shall rely on all Site Investigation Reports referred to in the **SCC** supplemented by any information obtained by the Contractor.
- 13.2 Detailed engineering shall proceed only on the basis of the feasibility or preliminary engineering study made which establishes the technical viability of the project and conformance to land use and zoning guidelines prescribed by existing laws. The findings contained in the feasibility study, if undertaken for the project, shall be examined. If, in the course of this exercise, it is found that amendments would be desirable in the design standards of principal features, as proposed, specific recommendations for such changes shall be supported by detailed justifications, including their effects on the cost, and the economic justifications, if necessary.
- 13.3 A schedule of detailed engineering activities shall include the following:
- a) Survey;
 - b) Site Investigation;
 - c) Soils and Foundation Investigation;
 - d) Construction Materials Investigation;
 - e) Preparation of Design Plans;
 - f) Preparation of Technical Specifications;
 - g) Preparation of Quantity and Cost Estimates;
 - h) Preparation of Scope of Work;
 - i) Preparation of Proposed Construction Schedule (and estimated Cash Flow for projects with Schedule over six (6) months;

¹¹ Also known as "An Act for the Protection of Persons Furnishing Material and Labor for the Construction Of Public Works".

- j) Preparation of Site or Right-of-Way Plans including Schedule of Acquisition;
 - k) Preparation of Utility Relocation Plan;
 - l) Preparation and Submission of Design Report;
 - m) Environmental Impact Statement for critical project, as defined by the Department of Environment and Natural Resources;
 - n) Preparation of minimum requirements for a Construction Safety and Health Program for the project being considered;
 - o) Value Engineering Studies; and
 - p) Preparation of report on asset climate hazards, risk assessment, disaster response strategies, and readiness planning.
- 13.4 Work under detailed architectural and engineering design shall include, among others, the items stated in Section 8.3 of the IRR.

14) Licenses and Permits

The Procuring Entity may, if requested by the Contractor, assist him in applying for permits, licenses or approvals, which are required for the Works.

15) Contractor's Risk and Warranty Security

- 15.1 From the time project construction commenced up to final acceptance, the Contractor shall assume full responsibility for any damage or destruction of the works, except those occasioned by force majeure; and the safety, protection, security, and convenience of its personnel, third parties, and the public at large, as well as the works, equipment, installation and the like to be affected by its construction work.
- 15.2 The defects liability period for infrastructure projects shall be one (1) year from project completion up to final acceptance by the Procuring Entity. During this period, the Contractor shall undertake the repair works, at its own expense, of any damage to the Works on account of the use of materials of inferior quality, defects in the construction, or due to any violation of the terms of the contract, within ninety (90) calendar days from the time the HoPE has issued an order to undertake repair. In case of failure or refusal to comply with this mandate, the Procuring Entity shall undertake such repair works and shall be entitled to full reimbursement of expenses incurred therein upon demand.
- 15.3 The defects liability period shall be covered by the performance security of the Contractor required in Section 68 of the IRR, which shall guarantee that the Contractor performs its responsibilities stated in **GCC** Clause 15.1 Unless otherwise indicated in the **SCC**, in case the Contractor fails to comply with the preceding paragraph, the Procuring Entity shall forfeit its performance security, subject its properties to attachment or garnishment proceedings, and may impose the appropriate penalty under Sections 99, 100, and 101 of the IRR. All payables of the GoP in its favor shall be offset to recover the costs.
- 15.4 The following persons shall be held responsible for "Structural Defects," i.e., major faults or flaws or deficiencies in one or more key structural elements of the project which may lead to structural failure of the completed elements or structure, or "Structural Failures," i.e., where one or more key structural elements in an

infrastructure facility fails or collapses, thereby rendering the facility or part thereof incapable of withstanding the design loads, and/or endangering the safety of the users or the general public:

- a) Contractor – Where Structural Defects or Failures arise due to faults attributable to improper construction, use of inferior quality/substandard materials, and any violation of the contract plans and specifications, the Contractor shall be held liable;
- b) Consultants – Where Structural Defects or Failures arise due to faulty and/or inadequate design and specifications as well as construction supervision, then the consultant who prepared the design or undertook construction supervision for the project shall be held liable;
- c) Procuring Entity’s Representatives or Project Manager or Construction Managers and Supervisors – The project owner’s representative, project manager, construction manager, and supervisor shall be held liable in cases where the Structural Defects or Failures are due to their willful intervention in altering the designs and other specifications; negligence or omission in not approving or acting on proposed changes to noted defects or deficiencies in the design and/or specifications and the use of substandard construction materials in the project;
- d) Third Parties - Third Parties shall be held liable in cases where Structural Defects or Failures are caused by work undertaken by them such as leaking pipes, diggings or excavations, underground cables and electrical wires, underground tunnel, mining shaft and the like, in which case the applicable warranty to such structure should be levied to third parties for their construction or restoration works; and
- e) Users - In cases where Structural Defects or Failures are due to abuse or misuse by the End-User or Implementing Unit of the constructed facility and/or non-compliance by a user with the technical design limits and/or intended purpose of the same, then the user concerned shall be held liable.

15.5 The warranty against Structural Defects or Failures, except those occasioned by force majeure, shall cover the period specified in the **SCC** reckoned from the date of issuance of the Certificate of Final Acceptance by the Procuring Entity. On the other hand, such warranty shall likewise be applied against non-structural defects for instances that pertain to faults or deficiencies in non-load bearing components or finishes of the Project, such as minor cracks, leaks, or defects in workmanship or materials, which do not affect the stability or safety of the structure but may impact its appearance, functionality, or usability.

15.6 To guarantee that the Contractor shall perform its responsibilities, it shall be required to post a warranty security, which shall be stated in Philippine Peso, in the form chosen by the Procuring Entity in accordance with the following schedule:

Form of Warranty	Amount of Warranty Security Not less than the Percentage (%) of Total Contract Price
(a) Cash or letter of credit issued by bank; Provided, however, that the letter of credit shall be confirmed or authenticated	Five Percent (5%)

<p>by a local bank, if issued by a foreign bank.</p> <p>For biddings conducted by LGUs, the Letter of Credit may be issued by other banks certified by the BSP as authorized to issue such financial instrument.</p>	
<p>(b) Bank guarantee confirmed by bank.</p> <p>For biddings conducted by LGUs, the bank draft/guarantee may be issued by other banks certified by the BSP as authorized to issue such financial instrument.</p>	<p>Ten Percent (10%)</p>
<p>(c) Surety bond callable upon demand issued by GSIS or any surety or insurance company duly certified by the Insurance Commission</p>	<p>Thirty Percent (30%)</p>

- 15.7 The warranty security shall be stated in Philippine Peso and shall remain effective within one (1) year from the date of issuance of the Certificate of Final Acceptance by the Procuring Entity, and returned only after the lapse of the said one (1) year period. This one (1) year period shall cover both structural and non-structural defects or failures; Provided, That in cases of structural defects or failures, warranties beyond the one (1) year period shall be subject to applicable laws, rules, and regulations such as the New Civil Code of the Philippines.
- 15.8 In case of structural/non-structural defects or failure occurring during the applicable warranty period provided in **GCC** Clause 15.5, the Procuring Entity shall undertake the necessary restoration or reconstruction works and shall be entitled to full reimbursement by the parties found to be liable for expenses incurred therein upon demand, without prejudice to the imposition of administrative sanctions as prescribed by RA No. 12009 and without prejudice to the imposition of civil and criminal sanctions as provided under applicable laws against the responsible persons as well as the forfeiture of the warranty security posted in favor of the Procuring Entity.

16) Procuring Entity's Risk

- 16.1 From the Start Date until the Certificate of Final Acceptance has been issued, the following are risks of the Procuring Entity:
- a) The risk of personal injury, death, or loss of or damage to property (excluding the Works, Plant, Materials, and Equipment), which are due to:
 - i) any type of use or occupation of the Site authorized by the Procuring Entity after the official acceptance of the Works; or
 - ii) negligence, breach of statutory duty, or interference with any legal right by the Procuring Entity or by any person employed or contracted by it, except the Contractor.
 - b) The risk of damage to the Works, Plant, Materials, and Equipment to the extent that it is due to a fault of the Procuring Entity or in the Procuring Entity's design, or due to war or radioactive contamination directly affecting the country where the Works are to be executed.

17) Insurance

- 17.1 The Contractor shall, under its name and at its own expense, obtain and maintain, for the duration of this Contract, the following insurance coverage:
- a) Contractor's All Risk Insurance, with an exception for Simple Infrastructure Projects, as applicable;
 - b) Transportation to the project Site of Equipment, Machinery, and Supplies owned by the Contractor;
 - c) Personal injury or death of Contractor's employees; and
 - d) Comprehensive insurance for third party liability to Contractor's direct or indirect act or omission causing damage to third persons.

17.2 The Contractor shall provide evidence to the Procuring Entity that the insurances required under this Contract have been effected and shall, within a reasonable time, provide copies of the insurance policies to the Procuring Entity.

17.3 The Contractor shall notify the insurers of changes in the nature, extent, or program for the execution of the Works and ensure the adequacy of the insurances at all times in accordance with the terms of this Contract and shall produce to the Procuring Entity the insurance policies in force including the receipts for payment of the current premiums.

The above insurance policies shall be obtained from any reputable insurance company approved by the Procuring Entity.

17.4 If the Contractor fails to obtain and keep in force the insurances referred to herein or any other insurance required to be obtained under the terms of this Contract, the Procuring Entity may obtain and keep in force any such insurances and pay such premiums as may be necessary for the purpose. From time to time, the Procuring Entity may deduct the amount it shall pay for said premiums including twenty five percent (25%) therein from any monies due, or which may become due, to the Contractor, without prejudice to the Procuring Entity exercising its right to impose other sanctions against the Contractor pursuant to the provisions of this Contract.

17.5 In the event the Contractor fails to observe the above safeguards, the Procuring Entity may, at the Contractor's expense, take whatever measure is deemed necessary for its protection and that of the Contractor's personnel and third parties, and/or order the interruption of dangerous Works. In addition, the Procuring Entity may refuse to make the payments under GCC Clause 9 until the Contractor complies with this Clause.

17.6 The Contractor shall immediately replace the insurance policy obtained as required in this Contract, without need of the Procuring Entity's demand, with a new policy issued by a new insurance company acceptable to the Procuring Entity for any of the following grounds:

- a) The issuer of the insurance policy to be replaced has:
 - i) become bankrupt;
 - ii) been placed under receivership or under a management committee;

- iii) been sued for suspension of payment;
- iv) been suspended by the Insurance Commission and its license to engage in business or its authority to issue insurance policies has been cancelled; or
- v) Where reasonable grounds exist that the insurer may not be able, fully and promptly, to fulfill its obligation under the insurance policy.

18) Liquidated Damages

- 18.1 When the Contractor fails to satisfactorily complete the Works under the contract within the specified contract duration, inclusive of duly granted time extensions, if any, the Contractor shall be liable for liquidated damages in an amount equal to at least one-tenth (1/10) of one percent (1%) of the cost of the unperformed portion of the Works for every day of delay.
- 18.2 In computing liquidated damages, the Procuring Entity shall determine the usability of the project. A project or a portion thereof may be deemed usable when it starts to provide the desired benefits as certified by the End-User or Implementing Unit and approved by the HoPE.
- 18.3 To be entitled to liquidated damages, the Procuring Entity does not have to prove that it has incurred actual damages. Such amount shall be deducted from any money due, or which may become due the Contractor under the contract, collected from the retention money or other securities posted by the Contractor, or a combination thereof, whichever is convenient to the Procuring Entity.
- 18.4 In case the total sum of liquidated damages reaches ten percent (10%) of the total contract price, the Procuring Entity may rescind or terminate the contract, without prejudice to other courses of action and remedies available under the circumstances.
- 18.5 If the Intended Completion Date is extended after liquidated damages have been paid, the Procuring Entity shall correct any overpayment of liquidated damages by the Contractor by adjusting the next payment schedule.

19) Settlement of Disputes

- 19.1 Any dispute arising from the implementation of a contract covered by the Act and the IRR shall primarily be resolved and settled amicably by mutual consultation or agreement.
- 19.2 In case of failure to settle the dispute amicably, the parties may mutually agree in writing to resort to other modes of alternative dispute resolution (ADR) to promote efficiency in the procurement process. Accordingly, they are encouraged to select the most expeditious mode of ADR available.

If arbitration is chosen as the ADR method, this shall be incorporated as a provision in the contract and referred to the Arbitrator specified in the **SCC**.
- 19.3 If the dispute remains unresolved after exhausting the remedies provided above, it may be submitted to other forms of ADR, such as mediation, conciliation, early neutral evaluation, mini-trial, or any combination thereof, in accordance with RA No. 9285, otherwise known as the "Alternative Dispute Resolution Act of 2004". However,

disputes that are within the competence or jurisdiction of the Construction Industry Arbitration Commission shall be referred to the same for resolution.¹²

20) Liability of the Contractor

Subject to additional provisions, if any, set forth in the **SCC**, the Contractor's liability under this Contract shall be as provided by the laws of the Republic of the Philippines.

21) Termination for Breach of Contract

21.1 The Procuring Entity shall terminate the contract for breach thereof when any of the following conditions are present:

- a) Due to the Contractor's fault and while the project is on-going, it has incurred negative slippage of fifteen percent (15%) or more in accordance with Presidential Decree No. 1870, s. 1983;
- b) Due to the Contractor's fault and after the contract time has expired, it has incurred a negative slippage of ten percent (10%) or more in the completion of the work;
- c) The Contractor abandons the contract works, plainly demonstrates an intention not to continue the performance of the Contractor's obligations under the contract, refuses or fails to comply with the Procuring Entity's instructions, or fails to proceed expeditiously and without delay despite a written notice by the Procuring Entity;
- d) When the Contractor, without reasonable excuse, fails to comply with the Notice of Rejection given by the Project Engineer that, after examination therein, the Infrastructure Project is found to be defective or otherwise not in accordance with the Contract, or a Project Engineer's instruction to conduct remedial work, within 30 days after receiving the said notice;
- e) The Contractor does not actually have on the project site the minimum essential equipment listed on the Bid necessary to prosecute the Works in accordance with the approved work plan and equipment deployment schedule as required for the project;
- f) The Contractor does not execute the Works in accordance with the contract or persistently or flagrantly neglects to carry out its obligations under the contract;
- g) The Contractor neglects or refuses to remove materials or to perform a new work that has been rejected as defective or unsuitable;
- h) The Contractor subcontracts any part of the contract works without approval by the Procuring Entity; or
- i) The Contractor becomes bankrupt or insolvent; goes into liquidation, administration, reorganization, winding-up, or dissolution; becomes subject to the appointment of a liquidator, receiver, administrator, manager, or trustee;

¹² Executive Order No. 1008 (Construction Industry Arbitration Law); and Construction Industry Arbitration Commission Revised Rules of Procedure.

enters into a composition or arrangement with the Contractor's creditors; or any act is done or any event occurs which is analogous to or has a similar effect to any of these acts or events under applicable laws.

- 21.2 All materials on the Site, Plant, Works, including Equipment paid under this Contract, including those identified by the Procuring Entity in the SCC pursuant to GCC Clause 9.1, shall be deemed to be the property of the Procuring Entity if this Contract is terminated because of the Contractor's breach.

22) Termination Due to Force Majeure

- 22.1 For purposes of this Contract the terms "*force majeure*" and "fortuitous event" may be used interchangeably. In this regard, a fortuitous event or *force majeure* shall be interpreted to mean an event which could not have been foreseen, or though foreseen, was inevitable. It shall not include ordinary unfavorable weather conditions, and any other cause the effects of which could have been avoided with the exercise of reasonable diligence by the Contractor.
- 22.2 If this Contract is discontinued by an outbreak of war or by any other similar event entirely outside the control of either the Procuring Entity or the Contractor, the Procuring Entity shall certify that this Contract has been discontinued. The Contractor shall make the Site safe and stop work as quickly as possible after receiving the certificate and shall be paid for all Works carried out before receiving it and for any Work carried out afterwards to which a commitment was made by the Procuring Entity.
- 22.3 If the event continues for a period of eighty-four (84) days, either party may then give notice of termination, which shall take effect twenty-eight (28) days after the giving of the notice.
- 22.4 After termination, the Contractor shall be entitled to payment of the unpaid balance of the value of the Works executed and of the materials and Plant, in relation to GCC Clause 9.1 and 21.2, adjusted by the following:
- (a) any sum to which the Contractor is entitled under GCC Clause 30; and
 - (b) any sum to which the Procuring Entity is entitled.
- 22.5 The net balance due shall be paid or repaid within a reasonable time period from the time of the notice of termination.

23) Termination by Contractor

The Contractor may terminate this Contract with the Procuring Entity if the Works are completely stopped for a continuous period of at least sixty (60) calendar days through no fault of its own, due to any of the following reasons:

- a) Failure of the Procuring Entity to deliver, within a reasonable time, supplies, materials, right-of-way, or other items it is obligated to furnish under the terms of this Contract;
- b) Substantial failure of the Procuring Entity to perform its obligations under the contract, and such failure constitutes a material breach of the Procuring Entity's obligations under the contract;
- c) Prolonged suspension by the Procuring Entity, through no fault of the Contractor, which affects the substantial part of the Infrastructure Project; or

- d) The prosecution of the Work is disrupted by the adverse peace and order situation, as certified by the Armed Forces of the Philippines Provincial Commander and approved by the Secretary of National Defense.

24) Termination for Convenience

The Procuring Entity, by notice sent to the Contractor, may terminate the Contract, in whole or in part, at any time, if it has determined the existence of any of the following conditions that make contract implementation economically, financially, or technically impractical or unnecessary:

- a) If physical and economic conditions have significantly changed so as to render the project no longer economically, financially, or technically feasible, as determined by the HoPE; or
- b) The HoPE has determined the existence of conditions that make project implementation impractical or unnecessary, such as, but not limited to, fortuitous events, changes in laws and government policies.

25) Termination for Unlawful Acts

The Procuring Entity may terminate the contract in case it is determined prima facie that the Contractor, including any joint venture partner therein, has engaged, before or during the implementation of the contract, in unlawful deeds and behaviors relative to contract acquisition and implementation. These unlawful acts include, but are not limited to, the following:

- a) Corrupt, fraudulent, collusive, coercive, and obstructive practices as defined in **ITB** Clause 3.1, unless otherwise specified in the **SCC**;
- b) Drawing up or using forged documents;
- c) Using adulterated materials, means, or methods, or engaging in production contrary to rules of science or trade; or
- d) Any other act analogous to the foregoing.

26) Termination for Other Causes

26.1 The Procuring Entity may terminate this Contract, in whole or in part, at any time for its convenience. The HoPE may terminate this Contract for the convenience of the Procuring Entity if physical and economic conditions have significantly changed so as to render the project no longer economically, financially, or technically feasible, as determined by the HoPE; or if the HoPE has determined the existence of conditions that make project implementation impractical or unnecessary, such as, but not limited to, fortuitous events, changes in laws and government policies.

26.2 The Procuring Entity or the Contractor may terminate this Contract if the other party causes a fundamental breach of this Contract.

26.3 Other breaches of Contract shall include, but shall not be limited to, the following:

- a) The Contractor stops work for twenty-eight (28) days when no stoppage of work is shown on the current Program of Work and the stoppage has not been authorized by the Procuring Entity;

- b) The Procuring Entity instructs the Contractor to delay the progress of the Works, and the instruction is not withdrawn within twenty-eight (28) days;
 - c) A payment certified by the Procuring Entity is not paid to the Contractor within eighty-four (84) days from the date of the Procuring Entity's certificate;
 - d) The Procuring Entity gives Notice that failure to correct a particular Defect is a fundamental breach of Contract and the Contractor fails to correct it within a reasonable period of time determined by the Procuring Entity;
 - e) The Contractor does not maintain a Security, which is required; and
 - f) The Contractor has delayed the completion of the Works by the number of days for which the maximum amount of liquidated damages can be paid, as defined in the GCC 18.
- 26.4 The Funding Source or the Procuring Entity, as appropriate, will seek the imposition of administrative sanctions as prescribed by RA No. 12009 and without prejudice to the imposition of civil and criminal sanctions as provided under applicable against individuals and organizations deemed to be involved with corrupt, fraudulent, or coercive practices.
- 26.5 When persons from either party to this Contract gives notice of a fundamental breach to the Procuring Entity in order to terminate the existing contract for a cause other than those listed under GCC Clause 26.3, the Procuring Entity shall decide whether the breach is fundamental or not.
- 26.6 If this Contract is terminated, the Contractor shall stop work immediately, make the Site safe and secure, and leave the Site as soon as reasonably possible.

27) Procedures for Termination of Contracts

- 27.1 The following provisions shall govern the procedures for the termination of this Contract:
- a) **Verification** - Upon receipt of a written report of acts or causes which may constitute grounds for termination as aforementioned, or upon its own initiative, the End-User or Implementing Unit shall, within a period of seven (7) calendar days, verify the existence of such grounds and cause the execution of a Verified Report, with all relevant evidence attached;
 - b) **Notice to Terminate** - Upon recommendation by the End-User or Implementing Unit, the HoPE shall terminate contracts only by written notice to the Contractor conveying the termination of the contract. The notice shall state:
 - (i) that the Contract is being terminated for any of the grounds aforementioned, and a statement of the acts that constitute the grounds constituting the same;
 - (ii) the extent of termination, whether in whole or in part;
 - (iii) an instruction to the Contractor to show cause as to why this contract should not be terminated; and

- (iv) special instructions of the Procuring Entity, if any.

The Notice to Terminate shall be accompanied by a copy of the Verified Report;

- c) **Show Cause** - Within a period of seven (7) calendar days from receipt of the Notice of Termination, the Contractor shall submit to the HoPE a verified position paper stating why the contract should not be terminated. If the Contractor fails to show cause after the lapse of the seven (7) day period, either by inaction or by default, the HoPE shall issue an order terminating the contract;
- d) **Rescission of Notice of Termination** - The Procuring Entity may, at any time before receipt of the Contractor's verified position paper, withdraw the Notice to Terminate if it is determined that certain items or works subject of the notice had been completed, delivered, or performed before the Contractor's receipt of the notice;
- e) **Decision** - Within a non-extendible period of ten (10) calendar days from receipt of the verified position paper, the HoPE shall decide whether or not to terminate the contract. It shall serve a written notice to the Contractor of its decision and, unless otherwise provided, the contract is deemed terminated from receipt of the Contractor of the notice of the decision. The termination shall only be based on the grounds stated in the Notice to Terminate.
- f) **Contract Termination Review Committee (CTRC)** - The HoPE may create a committee to assist him in the discharge of its functions under the IRR. All decisions recommended by the CTRC shall be subject to the approval of the HoPE
- g) **Take-over of Contracts** - If a Procuring Entity terminates the contract due to default, insolvency, or for cause, it may enter into a Negotiated Procurement (Take-over of Contracts) pursuant to Section 35.3 of the IRR.
- h) **Notice by Contractor** - The Contractor must serve a written notice to the Procuring Entity of its intention to terminate the contract at least thirty (30) calendar days before its intended termination. The contract is deemed terminated if it is not resumed in thirty (30) calendar days after the receipt of such notice by the Procuring Entity.

27.2 Notwithstanding Section 99 of RA No. 12009 and as provided by applicable laws, the Procuring Entity shall impose on Contractors after the termination of the contract, the penalty of suspension for one (1) year for the first offense, suspension for two (2) years for the second offense from participating in the public bidding process, for violations committed during the contract implementation stage, as stated in the **SCC**.

28) Approval of Drawings and Temporary Works by the Procuring Entity

- 28.1 All Drawings prepared by the Contractor for the execution of the Temporary Works, are subject to prior approval by the Procuring Entity before its use.
- 28.2 The Contractor shall be responsible for design of Temporary Works.
- 28.3 The Procuring Entity's approval shall not alter the Contractor's responsibility for design of the Temporary Works.

- 28.4 The Contractor shall obtain approval of third parties to the design of the Temporary Works, when required by the Procuring Entity.

29) Acceleration and Delays Ordered by the Procuring Entity

- 29.1 When the Procuring Entity wants the Contractor to finish before the Intended Completion Date, the Procuring Entity will obtain priced proposals for achieving the necessary acceleration from the Contractor. If the Procuring Entity accepts these proposals, the Intended Completion Date will be adjusted accordingly and confirmed by both the Procuring Entity and the Contractor.
- 29.2 If the Contractor's Financial Proposals for an acceleration are accepted by the Procuring Entity, they are incorporated in the Contract Price and treated as a Variation.

30) Contractor's Right to Claim

If the Contractor incurs cost as a result of any of the events under GCC Clauses 22, 23 and 24 in relation to GCC Clause 20, the Contractor shall be entitled to the amount of such cost. If as a result of any of the said events, it is necessary to change the Works, this shall be dealt with as a Variation.

31) Dayworks

- 31.1 Subject to GCC Clause 40 on Variation Order, and if applicable as indicated in the SCC, the Contractor shall determine the Dayworks rates to be included or indicated in the Bid. The Dayworks rates in the Contractor's bid shall be used for small additional amounts of work only when the Procuring Entity has given written instructions in advance for additional work to be paid for in that way.
- 31.2 All work to be paid for as Dayworks shall be recorded by the Contractor on forms approved by the Procuring Entity. Each completed form shall be verified and signed by the Procuring Entity within two (2) days of the work being done.
- 31.3 The Contractor shall be paid for Dayworks subject to obtaining signed Dayworks forms from both the Procuring Entity and Contractor.

32) Early Warning

- 32.1 The Contractor shall warn the Procuring Entity at the earliest opportunity of specific likely future events or circumstances that may adversely affect the quality of the work, increase the Contract Price, or delay the execution of the Works.
- 32.2 The Contractor shall cooperate with the Procuring Entity in making and considering proposals for how the effect of such an event or circumstance can be avoided or reduced by anyone involved in the work and in carrying out any resulting instruction of the Procuring Entity. Should such events or circumstances arise which increase the Contract price or delay the execution of Works, the provisions on variation order shall apply.

33) Program of Work

- 33.1 Within the time stated in the SCC, the Contractor shall submit to the Procuring Entity for approval a Program of Work showing the general methods, arrangements, order, and timing for all the activities in the Works.

- 33.2 An update of the Program of Work shall show the actual progress achieved on each activity and the effect of the progress achieved on the timing of the remaining work, including any changes to the sequence of the activities.
- 33.3 The Contractor shall submit to the Procuring Entity for approval an updated Program of Work at intervals no longer than the period stated in the **SCC**. If the Contractor does not submit an updated Program of Work within this period, the Procuring Entity may withhold the amount stated in the **SCC** from the next payment schedule and continue to withhold this amount until the next payment after the date on which the overdue Program of Work has been submitted.
- 33.4 The Procuring Entity's approval of the Program of Work shall not alter the Contractor's obligations. A revised Program of Work produced by the Contractor shall show the effect of any approved Variations, and shall include all Variations. The Contractor may revise the Program of Work, based on the Variation Order, and submit it to the Procuring Entity again.
- 33.5 When the Program of Work is updated, the Contractor shall provide the Procuring Entity with an updated cash flow forecast. The cash flow forecast shall include different currencies, as defined in the Contract, converted as necessary using the Contract exchange rates.

34) Management Conferences

- 34.1 Either the Procuring Entity or the Contractor may require the other to attend a Management Conference. The Management Conference shall review the plans for remaining work and deal with matters raised in accordance with the early warning procedure.
- 34.2 The Procuring Entity shall record the business of Management Conferences and provide copies of the record to those attending the Conference and to the Procuring Entity. The responsibility of the parties for the actions to be taken shall be decided by the Procuring Entity either at the Management Conference or after the Management Conference. The Procuring Entity shall communicate these responsibilities in writing to all who attended the Conference.

35) Bill of Quantities

- 35.1 The Bill of Quantities shall contain items of work for the construction, installation, testing, commissioning of work, materials, and labor among others, to be done by the Contractor.
- 35.2 The Bill of Quantities is used to calculate the Contract Price. The Contractor is paid for the quantity of the work done at the rate in the Bill of Quantities for each item.
- 35.3 If the final quantity of any work item completed differs from the quantity indicated in the Bill of Quantities, and the difference does not exceed twenty-five percent (25%) of the original quantity for that item, the Procuring Entity shall adjust the Contract accordingly.

This shall be allowed only if the total amount of all such changes does not go beyond ten percent (10%) of the total Contract price, subject to applicable laws, rules, and regulations.

- 35.4 If requested by the Procuring Entity, the Contractor shall provide the Procuring Entity with a detailed cost breakdown of any rate in the Bill of Quantities.

36) Instructions, Inspections and Audits

- 36.1 The Procuring Entity shall at all reasonable times during construction of the Works be entitled to examine, inspect, measure and test the materials and workmanship, and to check the progress of the construction.
- 36.2 If the Procuring Entity instructs the Contractor to carry out a test not specified in the Specification to check whether any work has a defect and the test shows that it does, the Contractor shall pay for the test and any samples. In the absence of any defect, the test shall be a compensation event with no adverse consequences to the contractor.
- 36.3 The Contractor shall permit the Funding Source named in the **SCC** to inspect the Contractor's accounts and records relating to the performance of the Contractor and to have them audited by auditors appointed by the Funding Source, if so required by the Funding Source.

37) Identifying Defects

The Procuring Entity shall check the Contractor's work and notify the Contractor of any defects that are found. Such checking shall not affect the Contractor's responsibilities. The Procuring Entity may instruct the Contractor to check noted defects and test any work that the Procuring Entity considers as substandard and/or defective.

38) Correction of Defects

- 38.1 The Procuring Entity shall give notice to the Contractor of any defects before the end of the Defects Liability Period, which is one (1) year from project completion up to final acceptance by the Procuring Entity.
- 38.2 Every time notice of a defect is given, the Contractor shall correct the notified defect within ninety (90) calendar days from the time the HoPE has issued an order to undertake repair.
- 38.3 The Contractor shall correct the defects which they notice themselves before the end of the Defects Liability Period.
- 38.4 The Procuring Entity shall certify that all defects have been duly corrected.

39) Uncorrected Defects

- 39.1 The Procuring Entity shall give the Contractor at least fourteen (14) days' notice of its intention to use a third party to correct a Defect. If the Contractor does not correct the Defect himself within the period, the Procuring Entity may have the Defect corrected by the third party. The cost of the correction will be deducted from the Contract Price.
- 39.2 The use of a third party to correct defects that are uncorrected by the Contractor will in no way relieve the Contractor of its liabilities and warranties under the Contract.

40) Variation Orders

- 40.1 Variation Orders may be issued by the Procuring Entity to cover any increase or decrease in quantities, including the introduction of new work items that are not

included in the original contract or reclassification of work items that are either due to change of plans, design or alignment to suit actual field conditions resulting in disparity between the preconstruction plans used for purposes of bidding and the "as staked plans" or construction drawings prepared after a joint survey by the Contractor and the Government after award of the contract.

Provided, That in case of positive or additive Variation Order/s, the cumulative amount thereof shall not exceed ten percent (10%) of the original contract price; Provided, further, That the scope of works shall not be reduced as to accommodate a positive Variation Order. In all cases, the addition of works under Variation Orders should be within the general scope of the project as bid and awarded.

- 40.2 Any cumulative positive Variation Order beyond ten percent (10%) of the original contract price shall be the subject of another procurement project to be bid out if the Works are separable from the original contract. In exceptional cases where it is urgently necessary to complete the original scope of work, the HoPE, upon the recommendation of the End-User or Implementing Unit, may authorize positive Variation Order/s resulting to a cumulative value of the positive Variation Orders beyond ten percent (10%) but not more than twenty percent (20%) of the original contract price.

All progress payments shall first be charged against the advance payment until the latter has been fully exhausted, at the option of the Procuring Entity.

- 40.3 A Variation Order may either be in the form of a Change Order or Extra Work Order:
- a) A Change Order may be issued by the HoPE or duly authorized representative to cover any increase or decrease in quantities of original work items in the contract.
 - b) An Extra Work Order may be issued by the implementing official to cover the introduction of new work necessary for the completion, improvement or protection of the project which was not included as items of work in the original contract, such as, where there are subsurface or latent physical conditions at the site differing materially from those indicated in the contract, or where there are duly unknown physical conditions at the site of an unusual nature differing materially from those ordinarily encountered and generally recognized as inherent in the work or character provided for in the contract.

- 40.4 For Variation Orders, the Contractor shall be paid for additional work items whose unit prices shall be derived based on the following:
- a) For additional or extra works duly covered by Change Orders involving work items which are exactly the same or similar to those in the original contract, the applicable unit prices of work items original contract shall be used.
 - b) For additional or extra works duly covered by Extra Work Orders involving new work items that are not in the original contract, the unit prices of the new work items shall be based on the direct unit costs used in the original contract (e.g., unit cost of cement, rebars, form lumber, labor rate, equipment rental, etc.). All new components of the new work item shall be fixed prices; Provided, The same is acceptable to both the Government and the Contractor; Provided further, That the direct unit costs of new components shall be based on the Contractor's estimate as validated by the Procuring Entity concerned via documented canvass in accordance with existing rules and regulations. The direct cost of the new work item shall then be combined with the mark-up

factor (i.e., taxes and profit) used by the Contractor in its bid to determine the unit price of the new work item.

40.5 Under no circumstances shall a Contractor proceed to commence work under any Change Order or Extra Work Order unless it has been approved by the HoPE or its duly authorized representative. However, under any of the following conditions, the Procuring Entity's representative or Project Engineer may, subject to the availability of funds and within the limits of its delegated authority, allow the immediate start of work under any Change Order or Extra Work Order:

- a) In the event of an emergency where the prosecution of the work is urgent to avoid detriment to public service, or damage to life and/or property; and/or
- b) When time is of the essence;

Provided, however, That such approval is valid on work done up to the point where the cumulative increase in value of work on the project which has not yet been duly fully approved does not exceed five percent (5%) of the adjusted original contract price.

Provided, further, That immediately after the start of work, the corresponding Change Order or Extra Work Order shall be prepared and submitted for approval in accordance with the abovementioned rules. Payments for Works satisfactorily accomplished on any Change Order or Extra Work Order may be made only after approval of the same by the HoPE or its duly authorized representative.

Provided, finally, That for a Change Order or Extra Work Order involving a cumulative amount exceeding five percent (5%) of the original contract price, no work thereon may be commenced unless said Change Order or Extra Work Order has been approved by the HoPE or its duly authorized representative.

41) Contract Completion

Once the project reaches an accomplishment of ninety-five percent (95%) of the total contract amount, the Procuring Entity may constitute an inspectorate team to conduct preliminary inspection and submit a punch-list to the Contractor in preparation for the final turnover of the project. Said punch-list will contain, among others, the remaining Works, Work deficiencies for necessary corrections, and the specific duration/time to fully complete the project within the approved remaining contract time. This, however, shall not preclude the claim of the Procuring Entity for liquidated damages, if applicable.

42) Suspension of Work

42.1 The Procuring Entity shall have the authority to suspend the work wholly or partly by written order for such period as may be deemed necessary, due to *force majeure* or any fortuitous event or for failure on the part of the Contractor to correct bad conditions which are unsafe for workers or for the general public, to carry out valid orders given by the Procuring Entity or to perform any provisions of the contract, or due to adjustment of plans to suit field conditions as found necessary during construction. The Contractor shall immediately comply with such order to suspend the work wholly or partly.

42.2 The Contractor or its duly authorized representative shall have the right to suspend work operation on any or all projects or activities along the critical path of activities after fifteen (15) calendar days from date of receipt of written notice from the Contractor to the district engineer, regional director, consultant or equivalent official, as the case may be, due to the following:

- a) There exist right-of-way problems which prohibit the Contractor from performing work in accordance with the approved construction schedule.
 - b) Requisite construction plans which must be owner furnished are not issued to the Contractor precluding any work called for by such plans.
 - c) Peace and order conditions that make it extremely dangerous, if not possible, to work. However, this condition must be certified in writing by the Philippine National Police station which has responsibility over the affected area and confirmed by the Department of the Interior and Local Government (DILG) Regional Director.
 - d) There was a failure on the part of the Procuring Entity to deliver government-furnished materials and equipment as stipulated in the contract.
 - e) Delay in the payment of Contractor's claim for progress billing beyond forty-five (45) calendar days from the time the Contractor's claim has been certified by the Procuring Entity's authorized representative that the documents are complete, unless there are justifiable reasons for the delay in payment which shall be communicated in writing to the Contractor.
- 42.3 In case of total suspension, or suspension of activities along the critical path, which is not due to any fault of the Contractor, the elapsed time between the effectivity of the order suspending operation and the order to resume work shall be allowed to the Contractor by adjusting the contract time accordingly.

43) Payment on Termination

- 43.1 If the Contract is terminated because of a breach of Contract by the Contractor, the Procuring Entity shall issue a certificate for the value of the work done and Materials ordered less advance payments received up to the date of the issue of the certificate, and less the percentage to apply to the value of the work not completed, as indicated in the **SCC**. Additional liquidated damages shall not apply. If the total amount due to the Procuring Entity exceeds any payment due to the Contractor, the difference shall be a debt payable to the Procuring Entity.
- 43.2 If the Contract is terminated for the Procuring Entity's convenience, or due to a breach of Contract by the Procuring Entity, the Procuring Entity shall issue a certificate for the value of the work done, Materials ordered, the reasonable cost of removal of Equipment, repatriation of the Contractor's personnel employed solely on the Works, and the Contractor's costs of protecting and securing the Works, and less advance payments received up to the date of the certificate.
- 43.3 The net balance due shall be paid or repaid within twenty-eight (28) days from the notice of termination.
- 43.4 If the Contractor has terminated the Contract under **GCC** Clauses 23 to 24, the Procuring Entity shall promptly return the Performance Security to the Contractor.

44) Extension of Contract Time

- 44.1 Should the amount of additional work or other special circumstances warrant the entitlement of the Contractor to an extension of contract time, the Procuring Entity shall determine the amount of such extension; Provided, That the Contractor has notified the Procuring Entity of its claim for extension of contract time prior to the expiration of

the contract time, and within thirty (30) calendar days after the additional work has been commenced or the circumstances leading to such claim have arisen, as the case may be, in order to give the Procuring Entity the opportunity to investigate the claim. Failure to provide such notice shall constitute a waiver of such a claim by the Contractor. Upon receipt of full and detailed particulars, the Procuring Entity shall examine the facts and extent of the delay and shall extend the contract time to complete the contract work when, in the Procuring Entity's opinion, the findings of facts justify an extension.

- 44.2 No extension of contract time shall be granted to the Contractor due to ordinary unfavorable weather conditions and inexcusable negligence of the Contractor to provide the required equipment, supplies, or materials.
- 44.3 Extension of contract time may be granted only when the affected activities fall within the critical path of the PERT, CPM, Precedence Diagram Method or any other project management tool.
- 44.4 No extension of contract time shall be granted when the reason given to support the request for extension was already considered in the determination of the original contract time during the conduct of detailed engineering and in the preparation of the contract documents as agreed upon by the parties before contract perfection.
- 44.5 Extension of contract time may be granted in the cases indicated in the SCC.
- 44.6 The written consent of the bank, or surety or insurance company, as the case may be, must be attached to any request of the Contractor for extension of contract time and submitted to the Procuring Entity for consideration and the validity of the Performance Security shall be correspondingly extended.
- 44.7 The Procuring Entity shall extend the Intended Completion Date if a Variation is issued which makes it impossible for the Intended Completion Date to be achieved by the Contractor without taking steps to accelerate the remaining work, which would cause the Contractor to incur additional costs. No payment shall be made for any event which may warrant the extension of the Intended Completion Date.
- 44.8 The Procuring Entity shall decide whether and by how much to extend the Intended Completion Date within twenty (20) days of the Contractor asking the Procuring Entity for a decision thereto after fully submitting all supporting information. If the Contractor has failed to give early warning of a delay or has failed to cooperate in dealing with a delay, the delay by this failure shall not be considered in assessing the new Intended Completion Date.

45) Price Escalation

In the event of an extraordinary increase in prices of specific components of the Infrastructure Project, price escalation may be considered, subject to prior approval of the GPPB. If the cost of construction components increases by more than ten percent (10%) of the unit price of work items, as determined against the prevailing price indices of the PSA, a price escalation may be authorized at a no-loss, no-gain basis, using the appropriate formula prescribed by the GPPB. For the purpose of this Section, the PSA shall ensure that its price indices are region-specific and updated on a monthly basis

46) Completion

The Contractor shall request the Procuring Entity to issue a Certificate of Completion of the Works, and the Procuring Entity will do so upon determining that the work is completed.

47) Taking Over

The Procuring Entity shall take over the Site and the Works within seven (7) days from the date of issuance of a Certificate of Completion; Provided, That it shall not release the Contractor of its responsibilities within the defects liability period.

48) Operating and Maintenance Manuals

- 48.1 If “as built” Drawings and/or operating and maintenance manuals are required, the Contractor shall supply them by the dates stated in the SCC.
- 48.2 If the Contractor does not supply the Drawings and/or manuals by the dates stated in the SCC, or they do not receive the Procuring Entity’s approval, the Procuring Entity shall withhold the amount stated in the SCC from payments due to the Contractor.

Section V. Special Conditions of Contract

Special Conditions of Contract

GCC Clause																			
1.1	The Intended Completion Date is 60 Calendar Days reckoned from the start date indicated in the Notice to Proceed (NTP).																		
1.2	The Procuring Entity is <i>Provincial Government of Camarines Norte, Provincial Capitol, Daet, Camarines Norte.</i>																		
1.3	The Site is located at P-4, Brgy. Mampurog, San Lorenzo Ruiz, Camarines Norte.																		
1.4	The start date shall be the date of receipt of the Notice to Proceed.																		
1.5	The Works consist of Construction of Covered Court, 12.60m x 3.50m, including roof extension with new supporting columns; construction of 307.91 sq.m. pavement.																		
2.2	Not Applicable.																		
5.1	The PGCN shall give possession of all parts of the Site to the Contractor from the start date indicated in the Notice to Proceed (NTP).																		
6.5	<p>The Contractor shall employ the following Key Personnel:</p> <table border="1" style="width: 100%; border-collapse: collapse;"> <thead> <tr> <th style="text-align: center;"><i>Item No.</i></th> <th style="text-align: center;"><i>Designation</i></th> <th style="text-align: center;"><i>Name</i></th> </tr> </thead> <tbody> <tr> <td style="text-align: center;">1</td> <td style="text-align: center;"><i>Project Manager</i></td> <td></td> </tr> <tr> <td style="text-align: center;">2</td> <td style="text-align: center;"><i>Project Engineer</i></td> <td></td> </tr> <tr> <td style="text-align: center;">3</td> <td style="text-align: center;"><i>Materials Engineer</i></td> <td></td> </tr> <tr> <td style="text-align: center;">4</td> <td style="text-align: center;"><i>Safety Officer</i></td> <td></td> </tr> <tr> <td style="text-align: center;">5</td> <td style="text-align: center;"><i>Construction Foreman</i></td> <td></td> </tr> </tbody> </table>	<i>Item No.</i>	<i>Designation</i>	<i>Name</i>	1	<i>Project Manager</i>		2	<i>Project Engineer</i>		3	<i>Materials Engineer</i>		4	<i>Safety Officer</i>		5	<i>Construction Foreman</i>	
<i>Item No.</i>	<i>Designation</i>	<i>Name</i>																	
1	<i>Project Manager</i>																		
2	<i>Project Engineer</i>																		
3	<i>Materials Engineer</i>																		
4	<i>Safety Officer</i>																		
5	<i>Construction Foreman</i>																		
7.1	No further instructions.																		
8.1	<p>The advance payment shall be in accordance with Section 71.2.5 of the IRR of R.A. No. 12009.</p> <p>The Procuring Entity shall make an advance payment to the contractor in an amount not exceeding 15% of the total contract price to be made in lump sum or, at the most, two installments according to a schedule specified in the Instruction to Bidders and other relevant bidding document.</p> <p>The advance payment shall be made only upon:</p> <ol style="list-style-type: none"> a. Written request of the contractor which shall form part of the contractor documents; and b. Submission of an irrevocable standby Letter of Credit of 																		

	equivalent value from a bank as confirmed by the Procuring Entity; a bank guarantee; or a surety bond callable upon demand issued by a duly licensed surety or insurance company, at the option of the Procuring Entity.
9.1	Materials and equipment delivered onsite but not yet incorporated in the Works shall NOT be included for payment.
9.4	The advance payment shall be repaid by the contractor by deducting <i>fifteen percent (15%)</i> from his periodic progress payments a percentage equal to the percentage of the total contract price used for the advance payment. The first progress payment may be paid by the Procuring Entity to the Contractor; Provided, that at least <i>five percent (5%)</i> of the Works has been accomplished as certified by the Procuring Entity.
12.7	No further instructions.
13.1	The site investigation reports are: <i>Site survey, boundary stake-out, topographic survey, geotechnical report and all signed and sealed pertinent data related to the conditions of the project site.</i>
15.3	No further instructions.
15.5	<i>In case of permanent structures, such as buildings of types 4 and 5 as classified under the National Building Code of the Philippines and other structures made of steel, iron, or concrete which comply with relevant structural codes (e.g., DPWH Standard Specifications), such as, but not limited to, steel/concrete bridges, flyovers, aircraft movement areas, ports, dams, tunnels, filtration and treatment plants, sewerage systems, power plants, transmission and communication towers, railway system, and other similar permanent structures: Fifteen (15) years.</i>
20	“No additional provision.” <i>Or if the Contractor is a joint venture, “All partners to the joint venture shall be jointly and severally liable to the Procuring Entity.”</i>
25(a)	No further instructions.
27.2	a) Failure of the Contractor, due solely to its fault or negligence, to mobilize and start work or performance within the specified period in the Notice to Proceed (“NTP”); b) Failure by the Contractor to fully and faithfully comply with its contractual obligations without valid cause, or failure by the Contractor to comply with any written lawful instruction of the Procuring Entity or its representative(s) pursuant to the implementation of the contract. For the procurement of infrastructure projects or consultancy contracts, lawful instructions include but are not limited to the following: i) Employment of competent technical personnel, competent engineers and/or work supervisors; ii) Provision of warning signs and barricades in accordance with approved plans and specifications and contract provisions;

	<p>iii) Stockpiling in proper places of all materials and removal from the project site of waste and excess materials, including broken pavement and excavated debris in accordance with approved plans and specifications and contract provisions;</p> <p>iv) Deployment of committed equipment, facilities, support staff and manpower; and</p> <p>v) Renewal of the effectivity dates of the performance security after its expiration during the course of contract implementation.</p> <p>c) Assignment and subcontracting of the contract or any part thereof or substitution of key personnel named in the proposal without prior written approval by the Procuring Entity.</p> <p>d) Poor performance by the Contractor or unsatisfactory quality and/or progress of work arising from its fault or negligence as reflected in the CPES rating sheet. In the absence of the CPES rating sheet, the existing performance monitoring system of the Procuring Entity shall be applied. Any of the following acts by the Contractor shall be construed as poor performance:</p> <p>i) Negative slippage of fifteen (15%) and above within the critical path of the project due entirely to the fault or negligence of the Contractor; and</p> <p>ii) Quality of materials and workmanship not complying with the approved specifications arising from the Contractor's fault or negligence.</p> <p>e) Willful or deliberate abandonment or non-performance of the project or contract by the Contractor resulting to substantial breach thereof without lawful and/or just cause.</p> <p>In addition to the penalty of suspension, the performance security posted by the Contractor shall also be forfeited.]</p>
31.1	Dayworks are applicable at the rate shown in the Contractor's original Bid subject to the guidelines on Variation Order in Section 71.2 of the IRR of RA12009.
33.1	The Contractor shall submit the Program of Work to the Procuring Entity within <i>10</i> days of delivery from the Notice of Award.
33.3	The period between Program of Work updates is <i>thirty (30)</i> days. The amount to be withheld for late submission of an updated Program of Work is <i>1% of the contract amount</i> .
36.3	The Funding Source is the PGCN-20% Development Fund CY2026 .
43.1	The percentage to apply to the value of the work not completed is <i>10%</i> .

44.5	<p>a) rainy/unworkable days considered unfavorable for the prosecution of the Works at the site, based on the actual conditions obtained at the site, in excess of the number of rainy/unworkable days pre-determined by the Procuring Entity in relation to the original contract time during the conduct of detailed engineering and in the preparation of the contract documents as agreed upon by the parties before contract perfection, and/or</p> <p>b) major calamities such as exceptionally destructive typhoons, floods and earthquakes, and epidemics,</p> <p>c) delays attributable to the Procuring Entity, such as non-delivery on time of materials, working drawings, or written information to be furnished by the Procuring Entity, non-acquisition of permit to enter private properties or non-execution of deed of sale or donation within the right-of-way resulting in complete paralyzation of construction activities, and</p> <p>d) other meritorious causes as determined by the Procuring Entity and approved by the HoPE such as shortage of construction materials, general labor strikes, and peace and order problems that disrupt construction operations through no fault of the Contractor may be considered as additional grounds for extension of contract time provided they are publicly felt and certified by appropriate government agencies such as DTI, DOLE, DILG, and DND, among others.</p>
48.1	<p>The Operating and Maintenance Manuals [one (1) original and three (3) copies and PDF file in flash drive]; and As-Built Drawings [One (1) Original in Mylar, three (3) Blueprint Copies and electronic file in USB] shall be submitted to and approved by the Procuring Entity or its duly authorized representative before the issuance of the Certificate of Completion.</p>
48.2	<p>The amount to be withheld for failing to produce “as built” drawings and/or operating and maintenance manuals by the date required is <i>is final billing and retention money</i>.</p>

Section VI. Specifications

ITEM 101 – REMOVAL OF STRUCTURES AND OBSTRUCTIONS

101.1 Description

This Item shall consist of the removal wholly or in part, and satisfactory disposal of all buildings, fences, structures, old pavements, abandoned pipe lines, and any other obstructions which are not designated or permitted to remain, except for the obstructions to be removed and disposed off under other items in the Contract. It shall also include the salvaging of designated materials and backfilling the resulting trenches, holes, and pits.

101.2 Construction Requirements

101.2.1 General

The Contractor shall perform the work described above, within and adjacent to the roadway, on Government land or easement, as shown on the Plans or as directed by the Engineer. All designated salvable material shall be removed, without unnecessary damage, in sections or pieces which may be readily transported, and shall be stored by the Contractor at specified places on the project or as otherwise shown in the Special Provisions. Perishable material shall be handled as designated in Subsection 100.2.2 Nonperishable material may be disposed off outside the limits of view from the project with written permission of the property owner on whose property the material is placed. Copies of all agreements with property owners are to be furnished to the Engineer. Basements or cavities left by the structure removal shall be filled with acceptable material to the level of the surrounding ground and, if within the prism of construction, shall be compacted to the required density.

101.2.2 Removal of Existing Bridges, Culverts, and other Drainage Structures

All existing bridges, culverts and other drainage structures in use by traffic shall not be removed until satisfactory arrangements have been made to accommodate traffic. The removal of existing culverts within embankment areas will be required only as necessary for the installation of new structures. Abandoned culverts shall be broken down, crushed and sealed or plugged. All retrieved culvert for future use as determined by the Engineer shall be carefully removed and all precautions shall be employed to avoid breakage or structural damage to any of its part. All sections of structures removed which are not designated for stockpiling or re-laying shall become the property of the Government and be removed from the project or disposed off in a manner approved by the Engineer.

Unless otherwise directed, the substructures of existing structures shall be removed down to the natural stream bottom and those parts outside of the stream shall be removed down to at least 300 mm (12 inches) below natural ground surface. Where such portions of existing structures lie wholly or in part within the limits for a new structure, they shall be removed as necessary to accommodate the construction of the proposed structure.

Steel bridges and wood bridges when specified to be salvaged shall be carefully dismantled without damaged. Steel members shall be match marked unless such match marking is waived by the Engineer. All salvaged material shall be stored as specified in Subsection 101.2.1.

Structures designated to become the property of the Contractor shall be removed from the right-of-way.

Blasting or other operations necessary for the removal of an existing structure or obstruction, which may damage new construction, shall be completed prior to placing the new work, unless otherwise provided in the Special Provisions.

101.2.3 Removal of Pipes Other than Pipe Culverts

Unless otherwise provided, all pipes shall be carefully removed and every precaution taken to avoid breakage or damaged. Pipes to be relaid shall be removed and stored when necessary so that there will be no loss of damage before re-laying. The Contractor shall replace sections lost from storage or damage by negligence, at his own expense.

101.2.4 Removal of Existing Pavement, Sidewalks, Curbs, etc.

All concrete pavement, base course, sidewalks, curbs, gutters, etc., designated for removal, shall be:

(1) Broken into pieces and used for riprap on the project, or

(2) Broken into pieces, the size of which shall not exceed 300 mm (12 inches) in any dimension and stockpiled at designated locations on the project for use by the Government, or

(3) Otherwise demolished and disposed off as directed by the Engineer. When specified, ballast, gravel, bituminous materials or other surfacing or pavement materials shall be removed and stockpiled as required in Subsection 101.2.1, otherwise such materials shall be disposed off as directed.

There will be no separate payment for excavating for removal of structures and obstructions or for backfilling and compacting the remaining cavity.

101.3 Method of Measurement

When the Contract stipulates that payment will be made for removal of obstructions on lump-sum basis, the pay item will include all structures and obstructions encountered within the roadway. Where the contract stipulates that payment will be made for the removal of specific items on a unit basis, measurement will be made by the unit stipulated in the Contract.

Whenever the Bill of Quantities does not contain an item for any aforementioned removals, the work will not be paid for directly, but will be considered as a subsidiary obligation of the Contractor under other Contract Items.

101.4 Basis of Payment

The accepted quantities, measured as prescribed in Section 101.3, shall be paid for at the Contract unit price or lump sum price bid for each of the Pay Items listed below that is included in the Bill of Quantities which price and payment shall be full compensation for removing and disposing of obstructions, including materials, labor, equipments, tools and incidentals necessary to complete the work prescribed in this Item. The price shall also include backfilling, salvage of materials removed, their custody, preservation, storage on the right-of-way and disposal as provided herein.

Payment will be made under:

Pay Item Number	Description	Unit of Measurement
101 (1)	Removal of Structures and Obstruction	Lump Sum
101 (2)	Removal of	Each

101 (3)	Removal of	Square Meter
101 (4)	Removal of	Linear Meter

ITEM 103 - STRUCTURE EXCAVATION

103.1 Description

This Item shall consist of the necessary excavation for foundation of bridge, culverts, underdrains, and other structures not otherwise provided for in the Specifications. Except as otherwise provided for pipe culverts, the backfilling of completed structures and the disposal of all excavated surplus

materials, shall be in accordance with these Specifications and in reasonably close conformity with the Plans or as established by the Engineer.

This Item shall include necessary diverting of live streams, bailing, pumping, draining, sheeting, bracing, and necessary construction of cribs and cofferdams, and furnishing the materials therefore, and the subsequent removal of cribs and cofferdams and the placing of all necessary backfill.

It shall also include the furnishing and placing of approved foundation fill material to replace unsuitable material encountered below the foundation elevation of structures.

No allowances will be made for classification of different types of material encountered.

103.2 Construction Requirements

103.2.1 Clearing and Grubbing

103.2.2 Excavation

General, all structures. The Contractor shall notify the Engineer sufficiently in advance of the beginning of any excavation so that cross-sectional elevations and measurements may be taken on the undisturbed ground. The natural ground adjacent to the structure shall not be disturbed without permission of the Engineer.

Trenches or foundation pits for structures or structure footing shall be excavated to the lines and grades or elevations shown on the Plans or as staked by the Engineer. They shall be of sufficient size to permit the placing of structures or structure footing of the full width and length shown. The elevations of the bottoms of footings, as shown on the Plans, shall be considered as approximate only.

and the Engineer may order; in writing, such changes in dimensions or elevations of footings as may be deemed necessary, to secure a satisfactory foundation.

Boulders, logs and other objectionable materials encountered in excavation shall be removed.

After each excavation is completed, the Contractor shall notify the Engineer to that effect and no footing, bedding material or pipe culvert shall be placed until the Engineer has approved the depth of excavation and the character of the foundation material.

Structures other than pipe culverts. All rocks or other hard foundation materials shall be cleaned all loose materials, and cut to a firm surface, either level, stepped, or serrated as directed by the Engineer. All seams or crevices shall be cleaned and grouted. All loose and disintegrated rocks and thin strata shall be removed. When the footing is to rest on material other than rock, excavation to final grade shall not be made until just before the footing is to be placed. When the foundation material is soft or mucky or otherwise unsuitable, as determined by the Engineer, the Contractor shall remove the unsuitable material and backfill with approved granular material. This foundation fill shall be placed and compacted in 150 mm (6 inches) layers up to the foundation elevation.

When foundation piles are used, the excavation of each pit shall be completed before the piles are driven and any placing of foundation fill shall be done after the piles are driven. After the driving is completed, all loose and displaced materials shall be removed, leaving a smooth, solid bed to receive the footing.

Pipe Culverts. The width of the pipe trench shall be sufficient to permit satisfactory jointing of the pipe and thorough tamping of the bedding material under and around the pipe.

Where rock, harden, or other unyielding material is encountered, it shall be removed below the foundation grade for a depth of at least 300 mm or 4 mm for each 100 mm of fill over the top of pipe, whichever is greater, but not exceed three-quarters of the vertical inside diameter of the pipe. The width of the excavation shall be at least 300 mm (12 inches) greater than the horizontal outside diameter of the pipe. The excavation below grade shall be backfilled with selected fine compressible material, such as silty clay or loam, and lightly compacted in layers not over 150 mm (6 inches) in uncompacted depth to form a uniform but yielding foundation.

Where a firm foundation is not encountered at the grade established, due to soft, spongy, or other unstable soil such as unstable soil under the pipe and for a width of at least one diameter on each side of the pipe shall be removed to the depth directed by the Engineer and replaced with approved granular

foundation fill material properly compacted to provide adequate support for the pipe, unless other special construction methods are called for on the Plans.

The foundation surface shall provide a firm foundation of uniform density throughout the length of the culvert and, if directed by the Engineer, shall be cambered in the direction parallel to the pipe centerline.

Where pipe culverts are to be placed in trenches excavated in embankments, the excavation of each trench shall be performed after the embankment has been constructed to a plane parallel to the proposed profile grade and to such height above the bottom of the pipe as shown on the Plans or directed by the Engineer.

103.2.3 Utilization of Excavated Material

All excavated material, so far as suitable, shall be utilized as backfill or embankment. The surplus materials shall be disposed off in such manner as not to obstruct the stream or otherwise impair the efficiency or appearance of the structure. No excavated materials shall be deposited at any times so as to endanger the partly finished structure.

103.2.4 Cofferdams

uitable and practically watertight cofferdams shall be used wherever water-bearing strata are encountered above the elevation of the bottom of the excavation. If requested, the Contractor shall submit drawings showing his proposed method of cofferdam construction, as directed by the Engineer.

Cofferdams or cribs for foundation construction shall in general, be carried well below the bottoms of the footings and shall be well braced and as nearly watertight as practicable. In general, the interior dimensions of cofferdams shall be such as to give sufficient clearance for the construction of forms and the inspection of their exteriors, and to permit pumping outside of the forms. Cofferdams or cribs which are tilted or moved laterally during the process of sinking shall be righted or enlarged so as to provide the necessary clearance.

When conditions are encountered which, as determined by the Engineer, render it impracticable to dewater the foundation before placing the footing, the Engineer may require the construction of a concrete for such a thickness as to resist any possible uplift. The concrete for such seal shall be placed

as shown on the Plans or directed by the Engineer. The foundation shall then be dewatered and the footing placed. When weighted cribs are employed and the mass is utilized to overcome partially the hydrostatic pressure acting against the bottom of the foundation seal, special anchorage such as dowels or keys shall be provided to transfer the entire mass of the crib to the foundation seal. When a foundation seal is placed under water. The cofferdams shall be vented or ported at low water level as directed.

Cofferdams shall be constructed so as to protect green concrete against damage from sudden rising of the stream and to prevent damage to the foundation by erosion. No timber or bracing shall be left in cofferdams or cribs in such a way as to extend into substructure masonry, without written permission from the Engineer.

Any pumping that may be permitted from the interior of any foundation enclosure shall be done in such a manner as to preclude the possibility of any portion of the concrete material being carried away. Any pumping required during the placing of concrete, or for a period of at least 24 hours thereafter, shall be done from a suitable sump located outside the concrete forms. Pumping to dewater a sealed cofferdam shall not commence forms. Pumping to dewater a sealed cofferdam shall not commence until the seal has set sufficiently to withstand the hydrostatic pressure.

Unless otherwise provided, cofferdams or cribs, with all sheeting and bracing involved therewith, shall be removed by the Contractor after the completion of the substructure. Removal shall be effected in such manner as not to disturb or mar finished masonry.

103.2.5 Preservation of Channel

Unless otherwise permitted, no excavation shall be made outside of caissons, cribs, cofferdams, or sheet piling, and the natural stream bed adjacent to structure shall not be disturbed without permission from the Engineer. If any excavation or dredging is made at the side of the structure before caissons, cribs, or cofferdams are sunk in place, the Contractor shall, after the foundation base is in place, backfill all such excavations to the original ground surface or stream bed with material satisfactory to the Engineer.

103.2.6 Backfill and Embankment for Structures Other than Pipe Culverts

Excavated areas around structures shall be backfilled with free draining granular material approved by the Engineer and placed in horizontal layers not over 150 mm (6inches) in thickness, to the level

of the original ground surface. Each layer shall be moistened or dried as required and thoroughly compacted with mechanical tampers.

In placing backfills or embankment, the material shall be placed simultaneously in so far as possible to approximately the same elevation on both sides of an abutment, pier or wall. If conditions require placing backfill or embankment appreciably higher on one side shall not be placed until masonry has been place for 14 days, or until tests made by the laboratory under the supervision of the Engineer establishes that the masonry has attained sufficient strength to withstand any pressure created by the methods used and materials placed without damage or strain beyond a safe factor.

Backfill or embankment shall not be placed behind the walls of concrete culverts or abutments or rigid frame structures until the top slab is placed and cured. Backfill and embankment behind abutments held at the top by the superstructure, and behind the sidewalls of culverts, shall be carried up simultaneously behind opposite abutments or sidewalls.

All embankments adjacent to structures shall be constructed in horizontal layers and compacted as prescribed in Subsection 104.3.3 except that mechanical tampers may be used for the required compaction. Special care shall be taken to prevent any wedging action against the structure and slopes bounding or within the areas to be filled shall be benched or serrated to prevent wedge action. The placing of embankment and the benching of slopes shall continue in such a manner that at all times there will be horizontal berm of thoroughly compacted material for a distance at least equal to the

height of the abutment or wall to the backfilled against except insofar as undisturbed material protrudes upon the area.

Broken rock or coarse sand and gravel shall be provided for a drainage filter at weepholes as shown on the Plans.

103.2.7 Bedding, Backfill, and Embankment for Pipe Culverts

Bedding, Backfill and Embankment for pipe culverts shall be done in accordance with Item 500, Pipe Culverts and Storm Drains.

103.3 Method of Measurement

103.3.1 Structure Excavation

The volume of excavation to be paid for will be the number of cubic metres measured in original position of material acceptably excavated on conformity with the Plans as directed by the Engineer, but in no case, except as noted, will any of the following volumes be included in the measurement for payment.

The volume outside of vertical planes 450 mm (18inches) outside of and parallel to the neat lines of footings and the inside walls of pipe and pipe-arch culverts at their widest horizontal dimensions. The

volume of excavation for culvert and sections outside the vertical plane for culverts stipulated in (1) above.

The volume outside of neat lines of underdrains as shown on the Plans, and outside the limits of foundation fill as ordered by the Engineer.

The volume included within the staked limits of the roadway excavation, contiguous channel changes, ditches, etc., for which payment is otherwise provided in the Specification,

Volume of water or other liquid resulting from construction operations and which can be pumped or drained away.

The volume of any excavation performed prior to the taking of elevations and measurements of the undisturbed ground.

The volume of any material rehandled ,except that where the Plans indicate or the Engineer directs the excavation after embankment has been placed and except that when installation of pipe culverts by the imperfect trench method specified in Item 500 is required, the volume of material re-excavated as directed will be included.

The volume of excavation for footings ordered at a depth more than 1.5m (60inches) below the lowest elevation for such footings shown on the original Contract Plans, unless the Bill of Quantities contains a pay item for excavation ordered below the elevations shown on the Plans for individual footings.

103.3.3 Free Draining Backfill

The Contractor shall supply, place and compact free-draining backfill to the lines, grades and dimensions and in the locations shown on the Drawings or instructed.

Free draining backfill shall be obtained from approved sources and shall be well graded with a maximum dimension of 150 mm, and not more than 5% smaller than 0.075 mm. Freed draining

backfill placed within 1 m of concrete structures shall not contain rocks larger than 75 mm in maximum dimension and shall be placed carefully so as not to damage the structure.

The material shall be handled and placed in such a manner as to prevent segregation.

Free draining backfill shall be deposited in horizontal layers not more than 150 mm thick after being compacted, and shall be thoroughly wetted for the purpose of compaction, as determined by the Engineer, and the moisture content shall be uniform throughout the layer.

Free draining backfill shall be compacted with 2 passes of a vibratory plate compactor having a minimum static mass of 100 kg.

103.3.5 Basis of Payment

The accepted quantities, measured as prescribed in Section 103.3, shall be paid for at the contract unit price for each of the particular pay items listed below that is included in the Bill of Quantities. The payment shall constitute full compensation for the removal and disposal of excavated materials

including all labor, equipment, tools and incidentals necessary to complete the work prescribed in this Item, except as follows:

Any excavation for footings ordered at a depth more than 1.5m below the lowest elevation shown on the original Contract Plans will be paid for as provided in Part K, Measurement and Payment, unless a pay item for excavation ordered below Plan elevation appears in the Bill of Quantities.

Concrete will be measured and paid for as provided under Item 405, Structural Concrete. Any roadway or borrow excavation required in excess of the quantity excavated for structures will be measured and paid for as provided under Item 102.

Payment will be made under:

Pay Item Number	Description	Unit of Measurement
103 (1)	Structure Excavation	Cubic Meter
103 (2)	Backfill (from structural excavation)	Cubic Meter
103 (3)	Foundation Fill	Cubic Meter
103 (4)	Excavation ordered below Plan elevation	Cubic Meter
103 (6)	Pipe culverts and drain excavation	Cubic Meter

ITEM 404 – REINFORCING STEEL

404.1 Description

This Item shall consist of furnishing, bending, fabricating and placing of steel reinforcement of the type, size, shape and grade required in accordance with this Specification and in conformity with the requirements shown on the Plans or as directed by the Engineer.

404.2 Material Requirements

Reinforcing steel shall meet the requirements of item 710, Reinforcing Steel and Wire

Rope.

4.4.3 Construction Requirements

404.3.1 Order Lists

Before materials are ordered, all order lists and bending diagrams shall be furnished by the Contractor, for approval of the Engineer. The approval of order lists and bending diagrams by the Engineer shall in no way relieve the Contractor of responsibility for the correctness of such lists and diagrams. Any expense incident to the revisions of materials furnished in accordance with such lists and diagrams to make them comply with the Plans shall be borne by the Contractor.

404.3.2 Protection of Material

Steel reinforcement shall be stored above the surface of the ground upon platforms, skids, or other supports and shall be protected as far as practicable from mechanical injury and surface deterioration caused by exposure to conditions producing rust. When placed in the work, reinforcement shall be free from dirt, detrimental rust, loose scale, paint, grease, oil, or other foreign materials. Reinforcement shall be free from injurious defects such as cracks and

laminations. Rust, surface seams, surface irregularities or mill scale will not be cause for rejection, provided the minimum dimensions, cross sectional area and tensile properties of a hand wire brushed specimen meets the physical requirements for the size and grade of steel specified.

404.3.3 Bending

All reinforcing bars requiring bending shall be cold-bent to the shapes shown on the Plans or required by the Engineer. Bars shall be bent around a circular pin having the following diameters (D) in relation to the diameter of the bar (d):

Nominal diameter, d, mm	Pin diameter (D)
10 to 20	6d
25 to 28	8d
32 and greater	10d

Bends and hooks in stirrups or ties may be bent to the diameter of the principal bar enclosed therein.

404.3.4 Placing and Fastening

All steel reinforcement shall be accurately placed in the position shown on the Plans or required by the Engineer and firmly held there during the placing and setting of the concrete. Bars shall be tied at all intersections except where spacing is less than 300mm in each directions, in which case, alternate intersections shall be tied. Ties shall be fastened on the inside.

Distance from the forms shall be maintained by means of stays, blocks, ties, hangers, or other approved supports, so that it does not vary from the position indicated on the Plans by more than 6mm. Blocks for holding reinforcement from contact with the forms shall be precast mortar blocks of approved shapes and dimensions. Layers of bars shall be separated by precast mortar blocks or by other equally suitable devices. The use of pebbles, pieces of broken stone or brick, metal pipe and wooden blocks shall not be permitted. Unless otherwise shown on the Plans or required by the Engineer, the minimum distance between bars shall be 40mm. Reinforcement in any member shall be placed and then inspected and approved by the Engineer before the placing of concrete begins. Concrete placed in violation of this provision may be rejected and removal may be required. If fabric reinforcement is shipped in rolls, it shall be straightened before being placed. Bundled bars shall be tied together at not more than 1.8m intervals.

404.3.5 Splicing

All reinforcement shall be furnished in the full lengths indicated on the Plans. Splicing of bars, except where shown on the Plans, will not be permitted without the written approval of the Engineer. Splices shall be staggered as far as possible and with a minimum separation of not less than 40 bar diameters. Not more than one-third of the bars may be spliced in the same cross-section, except where shown on the Plans.

Unless otherwise shown on the Plans, bars shall be lapped a minimum distance of:

Splice Type	Grade 40 min. lap	Grade 60 min. lap	But not less than
Tension	24 bar dia	36 bar dia	300 mm
Compression	20 bar dia	24 bar dia	300 mm

In lapped splices, the bars shall be placed in contact and wired together. Lapped splices will not be permitted at locations where the concrete section is insufficient to provide minimum clear distance of one and one-third the maximum size of coarse aggregate between the splice and the nearest adjacent bar. Welding of reinforcing steel shall be done only if detailed on the Plans or if authorized by the Engineer in writing. Spiral reinforcement shall be spliced by lapping at least one and a half turns or by butt welding unless otherwise shown on the Plans.

404.3.6 Lapping of Bar Mat

Sheets of mesh or bar mat reinforcement shall overlap each other sufficiently to maintain a uniform strength and shall be securely fastened at the ends and edges. The overlap shall not be less than one mesh in width.

404.4 Method of Measurement

The quantity of reinforcing steel to be paid for will be the final quantity placed and accepted in the completed structure.

No allowance will be made for tie-wires, separators, wire chairs and other material used in fastening the reinforcing steel in place. If bars are substituted upon the Contractor's request and approved by the Engineer and as a result thereof more steel is used than specified, only the mass specified shall be measured for payment.

No measurement or payment will be made for splices added by the Contractor unless directed or approved by the Engineer.

When there is no item for reinforcing steel in the Bill of Quantities, costs will be considered as incidental to the other items in the Bill of Quantities.

404.5 Basis of Payment

The accepted quantity, measured as prescribed in Section 404.4, shall be paid for at the contract unit price for Reinforcing Steel which price and payment shall be full compensation for furnishing and placing all materials, including all labor, equipment, tools and incidentals necessary to complete the work prescribed in this Item.

Payment will be made under:

Pay Item Number	Description	Unit of Measurement
404	Reinforcing Steel	Kilogram

ITEM 405 – STRUCTURAL CONCRETE

405.1 Description

405.1.1 Scope

This Item shall consist of furnishing, bending, placing and finishing concrete in all structures except pavements in accordance with this Specification and conforming to the lines, grades, and dimensions shown on the Plans. Concrete shall consist of a mixture of Portland Cement, fine aggregate, coarse aggregate, admixture when specified, and water mixed in the proportions specified or approved by the Engineer.

405.1.2 Classes and Uses of Concrete

Five classes of concrete are provided for in this Item, namely: A, B, C, P and Seal. Each class shall be used in that part of the structure as called for on the Plans.

The classes of concrete will generally be used as follows:

Class A – All superstructures and heavily reinforced substructures. The important parts of the structure included are slabs, beams, girders, columns, arch ribs, box culverts, reinforced abutments, retaining walls, and reinforced footings.

Class B – Footings, pedestals, massive pier shafts, pipe bedding, and gravity walls, unreinforced or with only a small amount of reinforcement.

Class C – Thin reinforced sections, railings, precast R.C. piles and cribbing and for filler in steel grid floors.

Class P – Prestressed concrete structures and members. Seal

– Concrete deposited in water.

405.2 Material Requirements

405.2.1 Portland Cement

It shall conform to all the requirements of Subsection 311.2.1.

405.2.2 Fine Aggregate

It shall conform to all the requirements of Subsection 311.2.2.

405.2.3 Coarse Aggregate

It shall conform all the requirements of Subsection 311.2.3 except that gradation shall conform to Table 405.1.

Table 405.1 – Grading Requirements for Coarse Aggregate

Sieve Designation		Mass Percent Passing				
Standard	Alternate	Class	Class	Class	Class	Class
Mm	US Standard	A	B	C	P	Seal
63	2-1/2"		100			

50	2"	100	95 – 100			
37.5	1-1/2"	95 – 100	-			100

25	1"	-	35 – 70		100	95 – 100
19.0	3/4"	35 – 70	-	100	95 – 100	-
12.5	1/2"	-	10 – 30	90 – 100	-	25 – 60
9.5	3/8"	10 – 30	-	40 – 70	20 – 55	-
4.75	No.4	0 - 5	0 - 5	0 – 15*	0 – 10*	0 – 10*

* The measured cement content shall be within plus (+) or minus (-) 2 mass percent of the design cement content.

405.2.4 Water

It shall conform to the requirements of Subsection 311.2.4

405.2.5 Reinforcing Steel

It shall conform to the requirements of Item 710, Reinforcing Steel and Wire Rope.

405.2.6 Admixtures

Admixtures shall conform to the requirements of Subsection 311.2.7

405.2.7 Curing Materials

Curing materials shall conform to the requirements of Subsection 311.2.8.

405.2.8 Expansion Joint Materials

Expansion joint materials shall be:

1. Preformed Sponge Rubber and Cork, conforming to AASHTO M 153.
2. Hot-Poured Elastic Type, conforming to AASHTO M 173.
3. Preformed Fillers, conforming to AASHTO M 213.

405.2.9 Elastomeric Compression Joint Seals

These shall conform to AASHTO M 220.

405.2.10 Elastomeric Bearing Pads

These shall conform to AASHTO M 251 or Item 412 – Elastomeric Bearing Pads.

405.2.11 Storage of Cement and Aggregates

Storage of cement and aggregates shall conform to all the requirements of Subsection 311.2.10.

405.3 Sampling and Testing of Structural Concrete

As work progresses, at least one (1) sample consisting of three (3) concrete cylinder test specimens, 150 x 300mm (6 x 12 inches), shall be taken from each seventy five (75) cubic meters of each class of concrete or fraction thereof placed each day.

Compliance with the requirements of this Section shall be determined in accordance with the following standard methods of AASHTO:

Sampling of fresh concrete	T 141
Weight per cubic metre and air content (gravi- Metric) of concrete	T 121
Sieve analysis of fine and coarse aggregates	T 27
Slump of Portland Cement Concrete	T 119
Specific gravity and absorption of fine aggregate	T 84

Tests for strength shall be made in accordance with the following:

Making and curing concrete compressive and flexural tests specimens in the field	T 23
Compressive strength of molded concrete Cylinders	T 22

405.4 Production Requirements

405.4.1 Proportioning and Strength of Structural Concrete

The concrete materials shall be proportioned in accordance with the requirements for each class of concrete as specified in Table 405.2, using the absolute volume method as outlined in the American Concrete Institute (ACI) Standard 211.1. "Recommended Practice for Selecting Proportions for Normal and Heavyweight Concrete". Other methods of proportioning may be employed in the mix design with prior approval of the Engineer. The mix shall either be designed or approved by the Engineer. A change in the source of materials during the progress of work may necessitate a new mix design.

The strength requirements for each class of concrete shall be as specified in Table 405.2.

Table 405.2 - Composition and Strength of Concrete for Use in Structures

Class Of Concrete	Minimum Cement Content Per m ³ kg (bag**)	Maximum Water/ Cement Ratio kg/kg	Consistency Range in Slump mm (inch)	Designated Size of Coarse Aggregate Square Opening Std. mm	Minimum Compressive Strength of 150x300mm Concrete Cylinder Specimen at 28 days, MN/m ² (psi)
-------------------------	---	---	---	--	--

A	360 (9 bags)	0.53	50 – 100 (2 – 4)	37.5 – 4.75 (1-1/2" – No. 4)	20.7 (3000)
---	-----------------	------	---------------------	---------------------------------	----------------

B	320 (8 bags)	0.58	50 – 100 (2 – 4)	50 – 4.75 (2" – No. 4)	16.5 (2400)
C	380 (9.5 bags)	0.55	50 – 100 (2 – 4)	12.5 – 4.75 (1/2" – No. 4)	20.7 (3000)
P	440 (11 bags)	0.49	100 max. (4 max.)	19.0 – 4.75 (3/4" – No. 4)	37.7 (5000)
Seal	380 (9.5 bags)	0.58	100 – 200 (4 - 8)	25 – 4.75 (1" – No. 4)	20.7 (3000)

* The measured cement content shall be within plus or minus 2 mass percent of the design cement content.

** Based on 40 kg/bag

405.4.2 Consistency

Concrete shall have a consistency such that it will be workable in the required position. It shall be of such a consistency that it will flow around reinforcing steel but individual particles

of the coarse aggregate when isolated shall show a coating of mortar containing its proportionate amount of sand. The consistency of concrete shall be gauged by the ability of the equipment to properly place it and not by the difficulty in mixing and transporting. The quantity of mixing water shall be determined by the Engineer and shall not be varied without his consent. Concrete as dry as it is practical to place with the equipment specified shall be used.

405.4.3 Batching

Measuring and batching of materials shall be done at a batching plant.

1. Portland Cement

Either sacked or bulk cement may be used. No fraction of a sack of cement shall be used in a batch of concrete unless the cement is weighed. All bulk cement shall be weighed on an approved weighing device. The bulk cement weighing hopper shall be properly sealed and vented to preclude dusting operation. The discharge chute shall not be suspended from the weighing hopper and shall be so arranged that cement will neither be lodged in it nor leak from it.

Accuracy of batching shall be within plus (+) or minus (-) 1 mass percent.

2. Water

Water may be measured either by volume or by weight. The accuracy of measuring the water shall be within a range of error of not more than 1 percent.

3. Aggregates

Stockpiling of aggregates shall be in accordance with Subsection 311.2.10. All aggregates whether produced or handled by hydraulic methods or washed, shall be stockpiled or binned for draining for at least 12 hours prior to batching. Rail shipment requiring more than 12 hours will be accepted as adequate binning only if the car bodies permit free drainage. If the aggregates contain high or non-uniform moisture content, storage or stockpile period in excess of 12 hours may be required by the Engineer.

Batching shall be conducted as to result in a 2 mass percent maximum tolerance for the required materials.

4. Bins and Scales

The batching plant shall include separate bins for bulk cement, fine aggregate and for each size of coarse aggregate, a weighing hopper, and scales capable of determining accurately the mass of each component of the batch.

Scales shall be accurate to one-half (0.5) percent throughout the range used.

5. Batching

When batches are hauled to the mixer, bulk cement shall be transported either in waterproof compartments or between the fine and coarse aggregate. When cement is placed in contact with moist aggregates, batches will be rejected unless mixed within 1-1/2 hours of such contact. Sacked cement may be transported on top of the aggregates.

Batches shall be delivered to the mixer separate and intact. Each batch shall be dumped cleanly into the mixer without loss, and, when more than one batch is

carried on the truck, without spilling of material from one batch compartment into another.

6. Admixtures

The Contractor shall follow an approved procedure for adding the specified amount of admixture to each batch and will be responsible for its uniform operation during the progress of the work. He shall provide separate scales for the admixtures which are to be proportioned by weight, and accurate measures for those to be proportioned by volume. Admixtures shall be measured into the mixer with an accuracy of plus or minus three (3) percent.

The use of Calcium Chloride as an admixture will not be permitted.

405.4.4 Mixing and Delivery

Concrete may be mixed at the site of construction, at a central point or by a combination of central point and truck mixing or by a combination of central point mixing and truck agitating. Mixing and delivery of concrete shall be in accordance with the appropriate requirements of AASHTO M 157 except as modified in the following paragraphs of this section, for truck mixing or a combination of central point and truck mixing or truck agitating. Delivery of concrete shall be regulated so that placing is at a continuous rate unless delayed by the placing operations. The intervals between delivery of batches shall not be so great as to allow the concrete in place to harden partially, and in no case shall such an interval exceed 30 minutes.

In exceptional cases and when volumetric measurements are authorized, for small project requiring less than 75 cu.m. per day of pouring, the weight proportions shall be converted to equivalent volumetric proportions. In such cases, suitable allowance shall be made for variations in the moisture condition of the aggregates, including the bulking effect in the fine aggregate. Batching and mixing shall be in accordance with ASTM C 685, Section 6 through 9.

Concrete mixing, by chute is allowed provided that a weighing scales for determining the batch weight will be used.

For batch mixing at the site of construction or at a central point, a batch mixer of an approved type shall be used. Mixer having a rated capacity of less than a one-bag batch shall not be used. The volume of concrete mixed per batch shall not exceed the mixer's nominal capacity as shown on the manufacturer's standard rating plate on the mixer except that an overload up to 10 percent above the mixer's nominal capacity may be permitted, provided concrete test data for strength, segregation, and uniform consistency are satisfactory and provided no spillage of concrete takes place. The batch shall be so charge into the drum that a portion of the water shall enter in advance of the cement and aggregates. The flow of water shall be uniform and all water shall be in the drum by the end of the first 15 seconds of the mixing period. Mixing time shall be measured from the time all materials, except water, are in the drum. Mixing time shall not be less than 60 seconds for mixers having a capacity of 1.5m³ or less. For mixers having a capacity greater than 1.5m³, the mixing time shall not be less than 90 seconds. If timing starts, the instant the skip reaches its maximum raised position, 4 seconds shall be added to the specified mixing time. Mixing time ends when the discharge chute opens.

The mixer shall be operated at the drum speed as shown on the manufacturer's name plate on the mixer. Any concrete mixed less than the specified time shall be discarded and disposed off by the Contractor at his own expenses.

The timing device on stationary mixers shall be equipped with a bell or other suitable warning device adjusted to give a clearly audible signal each time the lock is released. In case

of failure of the timing device, the Contractor will be permitted to continue operations while it is being repaired, provided he furnishes an approved timepiece equipped with minute and second hands. If the timing device is not placed in good working order within 24 hours, further use of the mixer will be prohibited until repairs are made.

Retempering concrete will not be permitted. Admixtures for increasing the workability, for retarding the set, or for accelerating the set or improving the pumping characteristics of the concrete will be permitted only when specifically provided for in the Contract, or authorized in writing by the Engineer.

1. Mixing Concrete: General

Concrete shall be thoroughly mixed in a mixer of an approved size and type that will insure a uniform distribution of the materials throughout the mass.

All concrete shall be mixed in mechanically operated mixers. Mixing plant and equipment for transporting and placing concrete shall be arranged with an ample auxiliary installation to provide a minimum supply of concrete in case of breakdown of machinery or in case the normal supply of concrete is disrupted. The auxiliary supply of concrete shall be sufficient to complete the casting of a section up to a construction joint that will meet the approval of the Engineer.

Equipment having components made of aluminum or magnesium alloys, which would have contact with plastic concrete during mixing, transporting or pumping of Portland Cement concrete, shall not be used.

Concrete mixers shall be equipped with adequate water storage and a device of accurately measuring and automatically controlling the amount of water used.

Materials shall be measured by weighing. The apparatus provided for weighing the aggregates and cement shall be suitably designed and constructed for this purpose. The accuracy of all weighing devices except that for water shall be such that successive quantities can be measured to within one percent of the desired amounts. The water measuring device shall be accurate to plus or minus 0.5 mass percent. All measuring devices shall be subject to the approval of the Engineer. Scales and measuring devices shall be tested at the expense of the Contractor as frequently as the Engineer may deem necessary to insure their accuracy.

Weighing equipment shall be insulated against vibration or movement of other operating equipment in the plant. When the entire plant is running, the scale reading at cut-off shall not vary from the weight designated by the Engineer more than one mass percent for cement, 1-1/2 mass percent for any size of aggregate, or one (1) mass percent for the total aggregate in any batch.

2. Mixing Concrete at Site

Concrete mixers may be of the revolving drum or the revolving blade type and the mixing drum or blades shall be operated uniformly at the mixing speed recommended by the manufacturer. The pick-up and throw-over blades of mixers shall be restored or replaced when any part or section is worn 20mm or more below the original height of the manufacturer's design. Mixers and agitators which have an accumulation of hard concrete or mortar shall not be used.

When bulk cement is used and volume of the batch is 0.5m³ or more, the scale and weigh hopper for Portland Cement shall be separate and distinct from the aggregate hopper or hoppers. The discharge mechanism of the bulk cement weigh hopper shall be interlocked against opening before the full amount of cement is in the hopper. The discharging mechanism shall also be interlocked against opening when the amount of cement in the hopper is underweight by more than one (1) mass percent or overweight by more than 3 mass percent of the amount specified.

When the aggregate contains more water than the quantity necessary to produce a saturated surface dry condition, representative samples shall be taken and the moisture content determined for each kind of aggregate.

The batch shall be so charged into the mixer that some water will enter in advance of cement and aggregate. All water shall be in the drum by the end of the first quarter of the specified mixing time.

Cement shall be batched and charged into the mixer so that it will not result in loss of cement due to the effect of wind, or in accumulation of cement on surface of conveyors or hoppers, or in other conditions which reduce or vary the required quantity of cement in the concrete mixture.

The entire content of a batch mixer shall be removed from the drum before materials for a succeeding batch are placed therein. The materials composing a batch except water shall be deposited simultaneously into the mixer.

All concrete shall be mixed for a period of not less than 1-1/2 minutes after all materials, including water, are in the mixer. During the period of mixing, the mixer shall operate at the speed for which it has been designed.

Mixers shall be operated with an automatic timing device that can be locked by the Engineer. The time device and discharge mechanics shall be so interlocked that during normal operation no part of the batch will be charged until the specified mixing time has elapsed.

The first batch of concrete materials placed in the mixer shall contain a sufficient excess of cement, sand, and water to coat inside of the drum without reducing the required mortar content of the mix. When mixing is to cease for a period of one hour or more, the mixer shall be thoroughly cleaned.

3. Mixing Concrete at Central Plant

Mixing at central plant shall conform to the requirements for mixing at the site.

4. Mixing Concrete in Truck

Truck mixers, unless otherwise authorized by the Engineer, shall be of the revolving drum type, water-tight, and so constructed that the concrete can be mixed to insure a uniform distribution of materials throughout the mass. All solid materials for the concrete shall be accurately measured and charged into the drum at the proportioning plant. Except as subsequently provided, the truck mixer shall be equipped with a device by which the quantity of water added can be readily verified. The mixing water may be added directly to the batch, in which case a tank is not

required. Truck mixers may be required to be provided with a means of which the mixing time can be readily verified by the Engineer.

The maximum size of batch in truck mixers shall not exceed the minimum rated capacity of the mixer as stated by the manufacturer and stamped in metal on the mixer. Truck mixing, shall, unless other-wise directed be continued for not less than 100 revolutions after all ingredients, including water, are in the drum. The mixing speed shall not be less than 4 rpm, nor more than 6 rpm.

Mixing shall begin within 30 minutes after the cement has been added either to the water or aggregate, but when cement is charged into a mixer drum containing water or surface wet aggregate and when the temperature is above 32°C, this limit shall be reduced to 15 minutes. The limitation in time between the introduction of the cement to the aggregate and the beginning of the mixing may be waived when, in the judgement of the Engineer, the aggregate is sufficiently free from moisture, so that there will be no harmful effects on the cement.

When a truck mixer is used for transportation, the mixing time specified in Subsection 405.4.4 (3) at a stationary mixer may be reduced to 30 seconds and the mixing completed in a truck mixer. The mixing time in the truck mixer shall be as specified for truck mixing.

5. Transporting Mixed Concrete

Mixed concrete may only be transported to the delivery point in truck agitators or truck mixers operating at the speed designated by the manufacturers of the equipment as agitating speed, or in non-agitating hauling equipment, provided the consistency and workability of the mixed concrete upon discharge at the delivery point is suitable point for adequate placement and consolidation in place.

Truck agitators shall be loaded not to exceed the manufacturer's guaranteed capacity. They shall maintain the mixed concrete in a thoroughly mixed and uniform mass during hauling.

No additional mixing water shall be incorporated into the concrete during hauling or after arrival at the delivery point.

The rate of discharge of mixed concrete from truck mixers or agitators shall be controlled by the speed of rotation of the drum in the discharge direction with the discharge gate fully open.

When a truck mixer or agitator is used for transporting concrete to the delivery point, discharge shall be completed within one hour, or before 250 revolutions of the drum or blades, whichever comes first, after the introduction of the cement to the aggregates. Under conditions contributing to quick stiffening of the concrete or when the temperature of the concrete is 30°C, or above, a time less than one hour will be required.

6. Delivery of Mixed Concrete

The Contractor shall have sufficient plant capacity and transportation apparatus to insure continuous delivery at the rate required. The rate of delivery of concrete during concreting operations shall be such as to provide for the proper handling,

placing and finishing of the concrete. The rate shall be such that the interval between batches shall not exceed 20 minutes. The methods of delivering and

handling the concrete shall be such as will facilitate placing of the minimum handling.

405.5 Method of Measurement

The quantity of structural concrete to be paid for will be the final quantity placed and accepted in the completed structure. No deduction will be made for the volume occupied by pipe less than 100mm (4 inches) in diameter or by reinforcing steel, anchors, conduits, weep holes or expansion joint materials.

405.6 Basis of Payment

The accepted quantities, measured as prescribed in Section 405.5, shall be paid for at the contract unit price for each of the Pay Item listed below that is included in the Bill of Quantities.

Payment shall constitute full compensation for furnishing, placing and finishing concrete including all labor, equipment, tools and incidentals necessary to complete the work prescribed in the item.

Payment will be made under:

Pay Item Number	Description	Unit of Measurement
405 (1)	Structural Concrete, Class A	Cubic Meter
405 (2)	Structural Concrete, Class B	Cubic Meter
405 (3)	Structural Concrete, Class C	Cubic Meter
405 (4)	Structural Concrete, Class P	Cubic Meter
405 (5)	Seal Concrete	Cubic Meter

11. ITEM 409 – WELDED STRUCTURAL STEEL

409.1 Description

This work shall consist of the joining of structural steel members with welds of the type, dimensions, and design shown on the Plans and in accordance with the Specifications.

It is the intent of this Specification to provide for work of a quality comparable to that required under the Standard Specifications for Welded Highway and Railway Bridges of the American Welding Society. In case of dispute or for situations not adequately provided for in this Specification, those designated Standard

Specifications shall be considered as the final authority and shall govern except as amended by the Special Provisions.

Welding of Structural Steel shall be done only when shown on the Plans or authorized in writing by the Engineer.

409.2 Materials Requirements

Steel base metal to be welded shall be open-hearth or electric furnace steel conforming to AASHTO M 183.

All arc-welding electrodes shall conform to the requirements of American Welding Society Specifications. Electrodes shall be of classification numbers E7016, E7018 or E7028 as required for the positions, type of current and polarity, and other conditions of intended use, and to conform to any special requirements indicated on the Plans.

Filler material to be used in the repair or strengthening of old structures or for joining new parts to existing steel members, shall be adopted to the material to be welded and may depart from the foregoing requirements only if agreed by the Engineer.

409.3 Construction Requirements

409.3.1 Equipment

409.3.1.1 General

All items of equipment for welding and gas cutting shall be so designed and manufactured and in such condition as to enable qualified welders to follow the procedures and attain the results prescribed in this Specification.

409.3.1.2 Arc-Welding Equipment

Welding generators and transformers shall be designed expressly for welding. They shall be capable of delivering steady currents adjustable through a range ample for the work requirements. They shall respond automatically and quickly to changes in power requirements due to variations in arc length and shall deliver full current promptly on striking an arc.

Welding cable shall have sufficient conductivity to avoid overheating and inadequate current at the arc and shall be effectively insulated against welding circuit voltage. Earth or ground connections and circuits shall be secured and adequate to carry the welding currents.

Electrode holders shall grip the electrode firmly and with good electrical contact.

Approved automatic welding heads may be used, with suitable auxiliary handling equipment to provide automatic instead of manual control of electrode and welding arc.

409.3.1.3 Gas-Cutting Equipment

Torches and tips shall be of proper size and type of the work at hand. Suitable regulators shall afford the welder complete control over the pressure and rate of flow of each gas.

409.3.1.4 Protective Equipment

All personnel protective equipment shall conform to the American Standard Association Code for such equipment.

The Contractor shall enforce the use of approved accessories necessary for the protection and convenience of the welders and for the proper and efficient execution of the work.

Suitable protection against the light of the arc shall be maintained by the Contractor when arc-welding operation might be viewed within harmful range by persons other than the actual welders and inspectors.

409.3.2 Welding

409.3.2.1 General

Welding shall be performed by the metal-arc process, using the electrodes specified with either direct or alternating current.

Surfaces to be welded shall be smooth, uniform and free from fins, tears, and other defects which would adversely affect the quality of the weld. Edges of material shall be trimmed by machining, chipping, grinding, or machine gas-cutting to produce a satisfactory welding edge wherever such edge is thicker than: 13 mm for sheared edge of material; 16 mm for toes of angles or rolled shapes (other than wide flange sections); 25 mm for universal mill plate or edges of flange sections.

The width of root face used, shall be not more than 1.5 mm for parts less than 10 mm in thickness nor more than 3 mm for parts 10 mm or more in thickness.

Butt welds shall be proportioned so that their surface contours will lie in gradual transition curves. For butt welded joints between base metal parts of unequal thickness, a transition shall be provided on a slope or level not greater than 1 in 2.5 to join the offset surfaces. This transition may be provided by sloping the surface of the weld metal or by bevelling the thicker part or by combination of these two methods.

Surfaces to be welded shall be free from loose scale, slag, rust, grease or other material that will prevent proper welding. Mill scale that withstands vigorous wire brushing or a light film of drying oil or rust inhibitive coating may remain. Surfaces within 50 mm of any weld location shall be free of any paint or other material that would prevent proper welding or produce objectionable fumes while welding.

No operation or actual welding or gas-cutting shall be performed on a member while it is carrying live load stress or while subject to shock and vibration and from moving loads. Welding and gas-cutting shall cease in advance of the application of such loads.

409.3.2.2 Welders

All welding shall be done by approved competent and experienced and fully qualified welders.

409.3.2.3 Preparation of Materials for Welding

Dimensional tolerance, straightness and flatness of the structural shapes and plates shall be within the limits prescribed in this Specification.

Structural steel which is to be welded shall preferably not be painted until all welding is completed.

Preparation of edges by gas-cutting shall, wherever practicable, be done by machine gas-cutting. Machine gas-cutting edges shall be substantially as smooth and regular as those produced by edge planning and shall be left free of slag. Manual gas cutting shall be permitted only where machine gas-cutting is not practicable and with the approval of the Engineer. The edge resulting from manual gas-cutting shall be inspected and smoothed with special care. All re-entrant corners shall be filleted to a radius at least 19 mm. The cut lines shall not extend beyond the fillet and all cutting shall follow closely the line prescribed.

409.3.2.4 Assembly

The parts to be joined by fillet welds shall be brought into a close contact as practicable, and no event shall be separated more than 5 mm. If the separation is 1.5 mm or greater, the leg of the fillet weld shall be increased by the amount of separation. The separation between faying surfaces of lap joints and of butt joints landing on a backing structure shall not exceed 1.5 mm. The fit of joints which are not sealed by welds throughout their length shall be sufficiently close to exclude water after painting. Where irregularities in rolled shape or plates, after straightening, do not permit contact within the above limits, the procedure necessary to bring the material within these limits shall be subject to the approval of the Engineer.

Cutting parts to be joined by butt welds shall be carefully aligned. Where the parts are effectively restrained against bending due to eccentricity or alignment, a maximum offset of 10 percent of the thickness or the thinner part joined, but in no case more than 3 mm, may be permitted as a departure from the theoretical alignment. In connecting alignment in such cases, the parts shall not be drawn into a greater slope than two degrees (1 in 30). Measurement of offset shall be between centerline of parts unless otherwise shown on the Plans.

When parts abutting edge to edge differ in thickness, the joint shall be of such form that the slope of either surface through the transition zone does not exceed 1 in 2.5, the thicker part being bevelled, if necessary.

Members to be welded shall be brought into correct alignment and held in position by bolts, clamps, wedges, guy lines, struts, other suitable devices or tack welds until welding has been completed. The use of jigs and fixtures is recommended where practicable. Such fastening devices as may be used shall be adequate to insure safety.

Plug and slot welds may be used to transmit shear in a lap joint or to prevent the buckling or separation of lapped parts.

The diameter of the hole for a plug weld shall not be less than the thickness of the part containing it plus 8 mm nor shall it be greater than 2.25 times the thickness of the weld.

The minimum center spacing of plug welds shall be four times the diameter of the hole.

The length of the slot for a slot weld not exceed ten times the thickness of the weld. The width of the slot shall not be less than the thickness of the part containing it plus 8 mm nor shall it be greater than 2.25 times the thickness of the weld.

The ends of the slot shall be semicircular or shall have the corners rounded to a radius not less than the thickness of the part containing it, except those ends which extend to the edge of the part.

The minimum spacing of lines of slot welds in a direction transverse to their length shall be 4 times the width of the slot.

The minimum center to center spacing in a longitudinal direction on any line shall be 2 times the length of the slot.

The thickness of plug or slot welds in material 16 mm or less in thickness shall be equal to the thickness of the material.

In material over 16 mm in thickness, it shall be at least one-half the thickness of the material but not less than 16 mm.

Tack welds, located where the final welds will later be made, shall be subject to the same quality requirements as the final weld. Tack welds shall be as small as practicable and where encountered in the final welding, shall be cleaned and fused thoroughly with the final weld. Defective, cracked or broken tack welds shall be removed before final welding.

Members or component parts of structures shall be assembled and matchmarked prior to erection to insure accurate assembly and adjustment of position on final erection. Painted assembly marks shall be removed from any surface to be welded.

409.3.2.5 Control of Distortion and Shrinkage Stresses

In assembling and joining parts of a structure or a built-up member and in welding reinforcing parts to existing members, the procedure and sequence of welding shall be such as will avoid distortion and minimize shrinkage stresses.

As far as practicable, long parallel lines of welding on a part or member shall be executed concurrently, and all welds shall be deposited in a sequence that will balance the applied heat of welding on various sides as much as possible while the welding progresses.

Before the commencement of welding on a structural member in which severe shrinkage stresses or distortion are likely to occur, a complete program for welding sequence and distortion control shall be submitted to the Engineer and shall be subject to his approval.

The direction of the general progression in welding on a member shall be from points where parts are relatively fixed in position, with respect to each other, toward points which have a greater relative freedom of movement.

Where part or member is to be welded on both ends into a rigid structure or assembly, the connection at which the greatest shrinkage will occur in the direction of the length of the part or member, shall be made while the part or member is free to move in the direction of the shrinkage; and the connection involving the least shrinkage shall be made last.

A weld designed to sustain tensile stress shall be made in such a way that their welding is being performed at any point, all parts that would offer restraint against shrinkage can shrink, deform or move enough to preclude serious shrinkage stresses.

In welding of built-up members of heavy sections, particularly those T or H-shapes where the flanges are considerably heavier than the stems or webs, and in any case where the component parts are 38 mm or greater in thickness, special care shall be exercised during welding to avoid weld cracking. In the welding of members of such heavy section, the temperature of contiguous areas about a welding operation shall be equal, and not less than 55°C. If necessary, the lighter parts shall be heated while the weld is cooling, to keep the temperature of contiguous parts substantially equal.

In the fabrication of cover-plated beams and built-up members, all shop splices in each component part shall be made before such component part is welded to other parts of the member.

In making all butt-welded splices in rolled shapes and in making butt-welded field splices in built-up sections (such as in H or I-sections) the sequence and procedure of welding shall be such as to take into account unequal amounts of expansion or contraction in the parts being welded. The procedure and sequence shall be such that while the weld and the heated base metal are contracting at any point, any part of the member that would furnish restraint against such contraction can move or shrink enough to prevent the shrinkage of the heated metal from producing harmful internal stresses. The procedure and sequence that is used for making such splices shall be planned in advance in full detail and submitted to the Engineer and shall be subject to his approval.

The ends of all butt welds in flanges of beams and girders shall be made with extension bars regardless of the thickness of such flanges.

Welding shall not be done when surfaces are wet from condensation or rain which is falling on the surfaces to be welded; nor during periods of high winds unless the welding operator and the work are properly protected.

409.3.2.6 Technique of Arch-Welding

The welding current shall conform with respect to voltage and current (and polarity, of direct current is used) to the recommendations of the manufacturer of the electrode being used, as indicated in the instructions that are included with each container of electrodes.

Arc lengths and electrical potential and current shall be suited to the thickness of material, type of groove and other circumstances attendant to the work.

The maximum size of electrode permitted shall be 5 mm with the following exceptions:

1. The maximum size for flat position welding of all passes except the root pass shall be 8 mm.
2. The maximum size for horizontal fillet welds shall be 6 mm.

The electrode for the single pass fillet weld and for the root passes of all multiple layer welds in all cases shall be of the proper size to insure thorough fusion and penetration with freedom from slag inclusions.

A single layer of the weld metal, whether deposited in one pass or made up of several parallel beads, shall not exceed 3 mm in thickness except that the bead at the root may be 6 mm in thickness if the position of welding and the viscosity of the weld metal permit control of the latter so that it does not over flow upon unfused base metal.

The maximum size of fillet weld which may be made in one pass shall be 8 mm except that for vertical welds made upward the maximum size made in one pass shall be 13 mm.

In vertical welding the first root pass shall be formed from the bottom upward. Succeeding passes may be formed by any technique that will fulfill the requirements of the Specification and Plans.

The electrode manipulation during welding shall insure that:

1. Complete fusion between the base metal and the deposited weld metal is obtained.

2. The melted base metal is replaced by weld metal so that no undercut remains along the edges of the finished weld.
3. The molten weld metal floats all slag, oxide and gases to the surface behind the advancing arc.

Each time the arc is started, either to begin a weld or to continue partly completed weld, the arch shall be manipulated to obtain complete fusion of the deposited weld metal with the base metal and with any previously deposited weld metal, before any progression of the arc along the joint.

At the completion of a pass or weld, the arc shall be manipulated so as to fill the crater with sound metal.

Before welding over previously deposited metal, the slag shall be removed and the weld and adjacent base metal shall be brushed clean. This requirement shall apply not only to cratered areas but also when welding is resumed after any interruption. It shall not, however, restrict the making of plug and slot welds, in accordance with the following paragraphs.

In making plug welds the following techniques shall be used:

1. For flat welds, the arc shall be carried around the root of the joint and then weaved along a spiral path to the center of the hole, fusing and depositing a layer of weld metal in the root and bottom of the joint. The arc shall then be carried to the periphery of the hole, and the procedure repeated, fusing and depositing successive layers to fill the hole to the depth required. The slag covering the weld metal shall be kept molten, or nearly so, until the

weld is finished. If the arc is broken, except briefly for changing electrodes, the slag must be allowed to cool and shall be completely removed before restarting the weld.

2. For vertical welds, the arc shall be started at the root of the joint, at the lower side of the hole and carried upward on the zigzag path, depositing a layer about 5 mm thick on the exposed face at the thinner plate and fused to it and to the side of the hole. After cleaning the slag from the weld, other layers shall be similarly deposited to fill the hole to the required depth.
3. For overhead welds, the procedure shall be the same as for flat welds except that the slag shall be allowed to cool and shall be completely removed after depositing each successive layer until the hole is filled to the required depth.

Slot welds shall be made with a technique similar to that specified above for plug welds, except that if the length of the slot exceeds three times the width, or if the slot extends to the edges of the part the technique specified above for making plug welds shall be followed for the type of flat position welds.

409.3.2.7 Details of Welds

The following tabulation shows that the relation between weld size and the maximum thickness of material on which various sizes of fillet welds may be used:

Size of Fillet Weld	Maximum Thickness of Part
5 mm	13 mm
6 mm	19 mm
8 mm	32 mm
10 mm	51 mm
13 mm	152 mm

16 mm over	152 mm
------------	--------

The maximum size of fillet weld that may be used along the edge of material 6 mm or more in thickness shall be 1.5 mm less than the thickness of the material.

The minimum effective length of fillet weld shall be four times its size and in no case less than 38 mm.

Fillet welds terminating at the corners of parts or members shall, wherever practicable, be turned continuously full size around the corners for a distance not less than twice the nominal size of the weld.

Intermittent fillet welds, preferably, shall not be used. They shall be permitted only where the required weld area is less than that of a continuous fillet weld of the minimum size. If used on main members, they shall be chain intermittent welds. In all other cases, chain intermittent welding is preferable to staggered intermittent welding.

Spacing of intermittent fillet welds shall be measured between the center of the weld segments. The spacing shall conform to the following requirements unless calculated stresses between the parts require closer spacing:

1. At the end of members, there shall preferably be continuous longitudinal fillet welds at least as long as the width of the element or member being connected.
2. The clear spacing in the direction of stress of stitch welds that connect plates to other plates or to shapes shall not exceed:
 - a. For compression members10 times the thickness of the thinner part but not more than 300 mm.
 - b. For tension members 14 times the thickness of the thinner part but not more than 300 mm.

The spacing transverse to the direction of stress shall not exceed 24 times the thickness of the thinner part connected.

3. For members composed of two or more rolled shapes in contact with one another, the longitudinal spacing of stitch welds shall not exceed 600 mm.

Fillet welds in holes or slots may be used to transmit shear in lap joints or to prevent the buckling or separation of lapped parts. The fillet welds in a hole or slot may overlap.

Seal welding shall preferably be accomplished by a continuous weld combining the function of sealing and strength, changing sections only as the required strength may necessitate.

Exposed faces of welds shall be made reasonably smooth and regular, shall conform as closely as practicable to the design requirements and shall not at any place be inside the intended cross-section. Weld dimension in excess of the design requirements shall not be a cause for rejection, but in case excess weld metal involves serious malformation, such work shall be rejected.

All fillet welds shall be of acceptable types. All fillet welds that carry reversed stresses running in a direction perpendicular to their longitudinal axis shall be of the concave type or the 0-gee type when the fillet weld is flushed with the edge of a member. When one of these types is specifically indicated on the Plans for a weld, it shall be of that type.

Butt welds shall preferably be made with a slight reinforcement, except as may be otherwise provided, and shall have no defects. The height of reinforcement shall be not more than 3 mm.

All butt welds, except produced with aid of backing material, shall have the root of the initial layer chipped out or otherwise cleaned to sound metal and welded in accordance with the requirements of the Specification. Butt welds made with the use of a backing of the same materials as the base metal shall have the weld metal thoroughly fused with the backing materials.

Ends of butt welds shall be extended past the edges of the parts joined by means of extension bars providing a similar joint preparation and having a width not less than the thickness of the thicker part jointed; or for material 19 mm or less in thickness, the ends of the welds shall be chipped or cut down to solid metal and side welds applied to fill out the ends to the same reinforcement as the face of the welds. Extension bars shall be removed upon completion and cooling of the weld and the ends of the weld made smooth and flush with the edges of the abutting parts.

409.3.2.8 Quality of Welds

Weld metal shall be solid throughout except that very small gas pockets and small inclusions of oxide or slag may be accepted if well dispersed and if none exceeds 1.5 mm in greatest dimension, and if the sum of the greatest dimensions of all such defects of weld metal area does not exceed 15 mm in an area of 10 cm².

There shall be complete fusion between the weld metal and the base metal and between successive passes throughout

the joint.

Welds shall be free from overlap and the base metal free from undercutting. All craters shall be filled to the full cross- section of the welds.

409.3.2.9 Correction

In lieu of rejection of an entire piece of member containing welding which is unsatisfactory or indicates inferior workmanship, the following corrective measures may be permitted by the Engineer whose specific approval shall be obtained for making each correction:

1. Removal of part or all of the welds shall be affected by chipping, grinding or gas-gouging.
2. Defective or unsound welds shall be corrected either by removing and replacing the welds, or as follows:
 - a. Excessive convexity – Reduce to size by removal of excess weld metal.
 - b. Shrinkage crack in base metal, craters and excessive porosity – Remove defective portion of base and weld metal down to sound metal and deposit additional weld metal.
 - c. Undercutting, undersize and excessive concavity – Clean and deposit additional weld metal.

- d. Overlapping and lack of fusion – Remove and replace the defective length of weld.
 - e. Slag inclusion – Remove those parts of the weld containing slag and fill with weld metal.
 - f. Removal of adjacent base metal during welding – Clean and form full size by depositing additional weld metal.
3. Where corrections require the depositing of additional weld metal, the electrode used shall be smaller than the electrode used in making the original weld.
 4. A cracked weld shall be removed throughout its length, unless by the use of acid etching, magnetic inspection or other equally positive means, the extent of the crack can be ascertained to be limited, in which case sound metal 50 mm or more beyond each end of the crack need not be removed.
 5. In removing defective parts of a weld, the gas-gouging, chipping or grinding shall not extend into the base metal any substantial amount beyond the depth of the web penetration unless cracks or other defects exist in the base metal.
 6. Where the work performed subsequent to the making of a deficient weld has rendered the weld inaccessible or has caused new conditions which would make the correction of the deficiency dangerous or ineffectual, the original condition shall be restored by renewal of welds or members, or both before making the necessary corrections, or else the deficiency shall be compensated by additional work according to a revised design approved by the Engineer.
 7. Caulking of welds shall not be done.

8. Before adding weld metal or rewelding, the surfaces shall be cleaned thoroughly. Where incomplete fusion is disclosed by chipping, grinding or gas gouging, to correct defects, that part of the weld shall be removed and rewelded.

409.3.2.10 Stress Relieving

Peening to reduce residual stress of multi-layer welds may be used only if authorized and ordered by the Engineer. Care shall be exercised to prevent overpeening which may cause overlapping, scaling, flecking or excessive cold working of weld and base metal.

409.3.2.11 Cleaning and Protective Coatings

Painting shall not be done until the work has been accepted and shall be in accordance with the Specification. The surface to be painted shall be cleaned of spatter, rust, loose scale, oil and dirt. Slag shall be cleaned from all welds.

Welds that are to be galvanized shall be treated to remove every particle of slag.

409.3.2.12 Identification

The operator shall place his identification mark with crayon, or paint, near the welds made by him.

409.3.2.13 Inspection

On completion of the welding work, inspection shall be carried out by an Inspector appointed by the Engineer.

The size and contour of welds shall be measured with suitable gauges. The inspector shall identify with a distinguishing mark all welds that he has inspected and accepted.

The Contractor shall remove and replace, or correct as instructed, all welds found defective or deficient. He shall also replace all methods found to produce inferior results, with methods which will produce satisfactory work.

In the event that fault welding or the removal for rewelding of faulty welding shall damage the base metal, the Contractor shall remove and replace the damaged material.

409.4 Measurement and Payment

Unless otherwise provided in the Special Provisions, welded structural steel structures shall not be measured and paid for separately, but the cost thereof shall be considered as included in the contract price for other items.

12. ITEM 1014 - PREPAINTED METAL SHEETS

1014.1 Description

This Item shall consist of furnishing all pre-painted metal sheet materials, tools and equipment, plant including labor required in undertaking the proper installation complete as shown on the Plans and in accordance with this Specification.

1014.2 Material Requirements

All pre-painted metal sheet and roofing accessories shall be oven baked painted true to profiles indicated on the •Plans.

1014.2.1 Pre-Painted Roofing Sheets

Pre-painted roofing sheets shall be fabricated from cold rolled galvanized iron sheets specially tempered steel for extra strength and durability. It shall conform to the material requirements defined in PNS 67: 1985. Profile section in identifying the architectural moulded rib to, be used are as follows: Regular corrugated, Quad-rib, Tri-wave, Rib-wide, twin-rib, etc. Desired color shall be subject to the approval of the Architect/Engineer.

1014.2.2 Gutters, Valleys, Flashings Hip and Ridge roll shall be fabricated from gauge 24 (.600 mm thick) cold-rolled plain galvanized iron sheets specially tempered steel. Profile section shall be as indicated on the Plans.

1014.2.3 Fastening hardware shall be of galvanized iron straps and rivets. G.I. straps are of .500 mm thick x 16 mm wide x 267 mm long (gauge 26 x 5/8" x 10-1/2") and standard rivets.

1014.2.4 Base metal thickness shall correspond to the following gauge designation available locally as follows:

a) Base Metal Thickness Designated Gauges

.400 mm thick Gauge 28

.500 mm thick Gauge 26

.600 mm thick Gauge 24

.800 mm thick Gauge 22

b) Protective Coatings Thickness

1. Zinc 34.4 microns

(244 gm/m²) 2. Paint coatings

Top coat 15.20 microns Bottom coat 6.8 microns

c) Overall thickness with protective coats

d) .400 mm .428-451 mm

.500 mm .532-551 mm

.600 mm .638-651 mm

e) Length of roofing sheets - available in cut to length long span length up to 18.29 meters f) Special length and thickness are available by arrangements.

1014.3 Construction Requirements

Before any installation work is commenced, the Contractor shall ascertain that the top faces of the purlins are in proper alignment. Correct the alignment as necessary in order to have the top faces of the purlins on an even plane.

1014.3.1 Handling/Lifting/Positioning of Sheets

Sheets shall be handled carefully to prevent damage to the paint coating. Lift all sheets or sheet packs on to the roof frame with the overlapping down-turned edge facing towards the side of the roof where installation will commence, otherwise sheets will have to be turned end-to-end during installation.

1014.3.2 Installation Procedure

1014.3.2.1 Start roofing installation by placing the first sheet in position with the downturned edge in line with other building elements and fastened to supports as recommended.

1014.3.2.2 Place the downturned edge of the next sheet over the edge of the first sheet, to provide side lap and hold the side lap firmly in place. Continue the same procedure for subsequent sheets until the whole roofing area is covered and/or (Adopt installation procedure provided in the instruction manual for each type of Architectural molded rib profile section).

1014.3.2.3 For walling applications follow the procedure for roofing. Allow a minimum end lap of 100 mm (4") for vertical walling.

1014.3.3 Gutters, Valleys, Flashing ridge and Hip rolls

Gutters, valleys, flashing ridge and hip rolls shall be fastened where indicated on the Plans by self-tapping screws or galvanized iron straps and rivets.

1014.3.4 End Laps

In case handling or transport consideration requires to use two or more end lapped sheets to provide full length coverage for the roof run, install each line of sheets from bottom to top or from eave line to apex of roof framing. Provide 150 mm minimum end lap.

1014.3.5 Anchorage/Fastening

1014.3.5.1 Pre-painted steel roofing sheets shall be fastened to the wood purlins with standard length G.I. straps and rivets.

1014.3.5.2 For steel frame up to 4.5 mm thick use self drilling screw No. 12 by 35 mm long hexagonal head with neoprene washer.

1014.3.5.3 For steel support up to 5 mm thick or more use thread cutting screw No. 12 by 40 mm long hexagonal head with neoprene washer.

1014.3.5.4 Side lap fastener use self drilling screw NO.10 by 16 mm long hexagonal head with neoprene washer.

1014.3.5.5 Valley fastened to lumber and for walling use self-drilling wood screw No. 12 by 25 mm long hexagonal head with neoprene washer.

1014.3.5.6 Valleys fastened to steel supports use selfdrilling screws, hexagonal head with neoprene washer. Drill size is 5 mm diameter.

1014.3.6 Cutting of Sheets

1014.3.6.1 In cutting pre painted steel roofing sheets and accessories to place the exposed color side down. Cutting shall be carried out on the ground and not over the top of other painted roofing product.

1014.3.6.2 Power cutting or drilling to be done or carried out on pre-painted products already installed or laid in position, the area around holes or cuts shall be masked to shield the paint from hot fillings.

1014.3.7 Storage and Protection

Pre-painted steel roofing, walling products and accessories should be delivered to the jobsite in strapped bundles. Sheets and/or bundles shall be neatly stacked in the ground and if left in the open it shall be protected by covering the stack materials with loose tarpauline.

1014.4 Method of Measurement

The work done under this Item shall be measured by actual area covered or installed with pre-painted steel roofing and/or walling in square meters and accepted to the satisfaction of the Engineer/Architect.

1014.5 Basis of Payment

The area of pre-painted steel roofing and/or walling in square meters as provided in Section 1014 shall be paid for at the unit bid or contract unit price which payment shall constitute full compensation including labor, materials, tools and incidents necessary to complete this Item.

Payment shall be made under:

Pay Item Number	Description	Unit of Measurement
1014 (a)	Pre painted metal sheets	m2

Section VII. Drawings

(SEE ATTACHED PLAN)

Section VIII. Bill of Quantities

BILL OF QUANTITIES

EXTENSION OF COVERED COURT AND FLOORING

P-4, Brgy. Mampurog, San Lorenzo Ruiz, Camarines Norte

Item No.	Scope of Work	Unit	Quantity	Unit Price	TOTAL
I	REMOVAL OF FENCE	Sq.m.	18.90		
II	STRUCTURE EXCAVATION	Cu.m.	51.14		
III	COLUMN FOOTING	Cu.m.	6.61		
IV	WALL FOOTING	Cu.m.	3.35		
V	RC COLUMN	Cu.m.	3.74		
VI	RC BEAM AND CORBEL	Cu.m.	2.23		
VII	MASONRY WORKS	Sq.m.	32.83		
VIII	SLAB ON FILL (REINFORCED)	Sq.m.	307.91		
IX	ROOF FRAMING	LS	1.00		
X	ROOF TINNING	Sq.m.	90.07		
XI	PAINTING WORKS	Sq.m.	62.96		
SPL-1	PROVISION OF FIELD OFFICE FOR THE ENGINEER (RENTAL BASIS)	Mos	2.00		
SPL-2	PROVISION OF 4x4 PICK UP TYPE SERVICE VEHICLE FOR THE ENGINEER ON RENTAL BASIS	Days	10.00		
SPL-3	PROJECT BILLBOARD/SIGNBOARD	Each	1.00		
SPL-4	OCCUPATIONAL SAFETY & HEALTH PROGRAM	LS	1.00		
TOTAL					

Amount in words:

Signature over Printed Name

Date

***Section IX. Philippine Bidding Documents
Related Forms***

TABLE OF CONTENTS

Bid Form.....	153
Contract Form.....	155
Omnibus Sworn Statement Form	158
Bid Securing Declaration Form	162
Affidavit of Site Inspection.....	165
Affidavit of availability of Key Personnel and Equipment.....	162
Key Personnel’s Certificate of Employment.....	167

Bid Form for Procurement of Infrastructure Projects

[Note: The duly accomplished form shall be submitted with the Bid]

BID FORM

Project Identification No.: *[Insert number]*

To: ENGR. JOSEPH V. ASCUTIA
Acting Governor
PLGU-Camarines Norte

Having examined the Philippine Bidding Documents (PBD) including the Supplemental Bid Bulletin Numbers *[insert numbers]*, the receipt of which is hereby duly acknowledged, we, the undersigned, declare that:

- a) I/We have no reservation to the PBD, including the Supplemental Bid Bulletins, for the Procurement Project *[Project Title]*;
- b) I/We offer to execute the Works for this Contract in accordance with the PBD;
- c) The total price of our Bid in words and figures, excluding any discount offered below, is *[insert information]*
- d) The discounts offered and the methodology for their application, if any, are: *[insert information]*; or indicate N/A if no discount offered
- e) The total bid price in words and figures, after applying the applicable discount, includes the cost of all taxes, such as, but not limited to *[specify the applicable taxes, e.g. (i) value added tax (VAT), (ii) income tax, (iii) local taxes, and (iv) other fiscal levies and duties]*, which are itemized in the Detailed Estimates.
- f) This Bid shall remain valid within a period stated in the PBD, and it shall be binding upon me/us at any time before the expiration of that period;
- g) If our bid is accepted, I/we commit to enter to a contract and provide a performance security in the form, amounts, and within the times prescribed in the PBD, and hereby acknowledge the consequences under the IRR of RA No. 12009 on forfeiture of Bid Security or enforcement of Bid Securing Declaration and on Blacklisting.

Until a formal Contract is prepared and executed, this Bid, together with your written acceptance thereof and your Notice of Award, shall be binding upon the Bidder.

I/We understand that you are not bound to accept the Lowest Calculated Bid or any Bid you may receive.

I/We certify/confirm that we comply with the eligibility requirements pursuant to the PBD.

The undersigned is authorized to submit the bid on behalf of *[Name of the Bidder]* as evidenced by the attached *[State the Written Authority]*.

I/We acknowledge that failure to sign each and every page of this Bid Form, including the attached Schedule of Prices, shall be a ground for the rejection of our bid.

Duly authorized to sign the Bid for and behalf of:

[Insert Bidder's Name]

[Signature over Printed Name]

[Position/Designation]

[Date]

Contract Form

[Note: The duly accomplished form is not required to be submitted with the Bid but shall be submitted within ten (10) days after receiving the Notice of Award]

CONTRACT FOR [Insert Project Title]

THIS CONTRACT executed on the ____ day of _____ 20____ between:

[Name of Procuring Entity], a government agency of the Republic of the Philippines, hereinafter called “the Entity”;

-and-

[Name of Contractor] Filipino of legal age or a company duly organized and existing under the laws of [city and country], with principal office at [insert address], hereinafter called “the Contractor”.

WHEREAS, the Entity invited Bids for certain goods and ancillary services, particularly *[Brief description of Project]*;

WHEREAS, the Contractor submitted a responsive bid and was awarded the contract for the procurement in the total amount of *[Contract price in words and figures, including currency]*, hereinafter referred to as the “Contract Price.”

NOW, THEREFORE, for and in consideration of the foregoing premises, the parties hereby agree as follows:

- 1) Unless otherwise stated, terms and expressions used in this Contract shall have the same meanings as those assigned to them in the Conditions of Contract, which form an integral part of this Contract.
- 2) The following documents as required by the Implementing Rules and Regulations of Republic Act No. 12009 shall be deemed to form and be read and construed as integral part of this Contract, *viz.*:
 - a) Philippine Bidding Documents (PBD);
 - i. Drawings/Plans;
 - ii. Scope of Work;
 - iii. Invitation to Bid;
 - iv. Instructions to Bidders;
 - v. Bid Data Sheet;
 - vi. Bid Form, including all the documents/statements contained in the Bidder’s bidding envelopes, as annexes, and all other documents submitted (e.g., Bidder’s response to request for clarifications on the bid), including corrections to the bid, if any, resulting from the Procuring Entity’s bid evaluation;
 - vii. Bill of Quantities;
 - viii. General and Special Conditions of Contract;
 - ix. Supplemental Bid Bulletins, if any; and
 - x. Other contract documents that may be required by existing laws and/or the Entity.
 - b) Winning bidder’s bid, including the Eligibility Requirements, Technical and Financial Proposals, and all other documents or statements submitted;
 - c) Performance Security;

- d) Notice of Award of Contract; and the Bidder's Conformance thereto; and
 - e) Other contract documents that may be required by existing laws and/or the Procuring Entity concerned in the PBD, such as but not limited to the Notice to Proceed and Warranty Security.
- 3) In consideration of the Contract Price of [*Contract Price in words and figures*], or such other sums as may be determined in accordance with the terms of the Contract, the Supplier agrees to deliver and perform the items and related services for the [*Project Title*] described herein in accordance with the terms and conditions specified in the Contract and its annexed documents.
 - 4) The [*Name of the Procuring Entity*] agrees to pay the above-mentioned sum to the Supplier in accordance with the schedule and manner provided in the Bidding Documents and its annexes.
 - 5) Any dispute, difference, or claim arising out of or relating to this Contract, including its existence, validity, interpretation, breach, or termination thereof, may be submitted to arbitration or other form of alternative dispute resolution in accordance with the applicable law, such as Republic Act (RA) No. 9285 (Alternative Dispute Resolution Act of 2004) or Executive Order No 1008, series 1985 (Construction Industry Arbitration Law).

IN WITNESS WHEREOF, the parties hereto have caused this Contract to be executed in accordance with the laws of the Republic of the Philippines on the day and year first above written

For the Procuring Entity
 Head of the Procuring Entity or Duly
 Authorized Representative

For the Bidder
 Duly authorized to sign the Contract for
 and behalf of [*Bidders Name*]:

[*Signature over Printed
 Name*][*Position/Designation*]
 [*Date*]

[*Signature over Printed Name*]
 [*Position/Designation*]
 [*Date*]

Signed in the presence of:

[*Name and Signature*]
 Witness – Procuring Entity

[*Name and Signature*]
 Witness- Supplier

ACKNOWLEDGMENT

BEFORE ME, A Notary Public for and in the _____, City/Province of _____, this _____ day of _____, 20____, personally appeared the above-named persons who have satisfactorily proven to me their identity, through their identifying documents written below their names and signatures, that they are the same persons who executed and voluntarily signed the foregoing instrument consisting of ____ pages, including this page where this Acknowledgement is written, which they acknowledged before me as their free and voluntary act and deed.

WITNESS MY HAND AND SEAL this ____ day of *[month]* *[year]*.

NAME OF NOTARY PUBLIC

Notarial Commission No. _____

Notary Public for _____ until _____

Roll of Attorneys No. _____

PTR No. __, *[date issued]*, *[place issued]*

IBP No. __, *[date issued]*, *[place issued]*

Doc. No. _____

Page No. _____

Book No. _____

Series of _____

Omnibus Sworn Statement Form

[Note: The duly accomplished form shall be submitted with the Bid]

REPUBLIC OF THE PHILIPPINES)
CITY/MUNICIPALITY OF _____) S.S.

OMNIBUS SWORN STATEMENT

I, *[Name of Affiant]*, of legal age, *[Civil Status]*, *[Nationality]*, and with residence at *[Address of Affiant]*, after having been duly sworn in accordance with law, do hereby depose and state that:

1) *Select one, delete the others:*

- *If sole proprietorship:* I am the sole proprietor or authorized representative of *[Name of Bidder]* with office address at *[Address of Bidder]*;
- *If partnership, corporation, cooperative, or joint venture:* I am the duly authorized and designated representative of *[Name of Bidder]* with office address at *[Address of Bidder]*;
- *If individual consultant not registered under a sole proprietorship, in case of Consulting Services:* I am the individual consultant or authorized representative of *[Name of Bidder]* with office address at *[Address of Bidder]*;

2) *Select one, delete the others:*

- *If sole proprietorship:* As the owner and sole proprietor or authorized representative of *[Name of Bidder]*, I have full power and authority to do, execute and perform any and all acts necessary to participate, submit the bid, and to sign and execute the ensuing contract for *[Project Title]* of the *[Name of the Procuring Entity]**[insert “as supported by the attached duly notarized Special Power of Attorney” for authorized representative]*;
- *If partnership, corporation, cooperative, or joint venture:* I am granted full power and authority to do, execute and perform any and all acts necessary to participate, submit the bid, and to sign and execute the ensuing contract for *[Project Title]* of the *[Name of the Procuring Entity]*, as supported by the attached duly notarized Special Power of Attorney, Board/Partnership Resolution, or Secretary’s Certificate, whichever is applicable;
- *If individual consultant not registered under a sole proprietorship, in case of Consulting Services:* As the individual consultant or authorized representative of *[Name of Bidder]*, I have full power and authority to do, execute and perform any and all acts necessary to participate, submit the bid, and to sign and execute the ensuing contract for *[Project Title]* of the *[Name of the Procuring Entity]*, as supported by the attached duly notarized Special Power of Attorney *for authorized representative*;

3) *[Name of Bidder]* is not “blacklisted” or barred from bidding by the Government of the Philippines or any of its agencies, offices, corporations, or Local Government Units, foreign government/foreign or international financing institution whose blacklisting rules have been recognized by the Government

Procurement Policy Board; by itself or by relation, membership, association, affiliation, or controlling interest with another blacklisted person or entity;

- 4) Each of the documents submitted in satisfaction of the bidding requirements is an authentic copy of the original, complete, and all statements and information provided therein are true and correct;
- 5) *[Name of Bidder]* is authorizing the Head of the Procuring Entity or its duly authorized representative(s) to verify all the documents submitted;
- 6) *Select one, delete the others:*
 - *If sole proprietorship* : The *[Name of Bidder]* and its spouse are not related by consanguinity or affinity up to the third civil degree to the Head of the Procuring Entity, Procurement Agent (if engaged), End-User or Implementing Unit, project consultants, head of the Project Management Office, or the members of the Bids and Awards Committee (BAC), the Technical Working Group, and the BAC Secretariat;
 - *If partnership* : The partnership itself and the partners of *[Name of Bidder]* are not related by consanguinity or affinity up to the third civil degree to the Head of the Procuring Entity, Procurement Agent (if engaged), End-User or Implementing Unit, project consultants, head of the Project Management Office, or the members of the Bids and Awards Committee (BAC), the Technical Working Group, and the BAC Secretariat;
 - *If cooperative:* The cooperative itself and members of the board of directors, general manager, or chief executive officer of *[Name of Bidder]* are not related by consanguinity or affinity up to the third civil degree to the Head of the Procuring Entity, Procurement Agent (if engaged), End-User or Implementing Unit, project consultants, head of the Project Management Office, or the members of the Bids and Awards Committee (BAC), the Technical Working Group, and the BAC Secretariat;
 - *If corporation, or joint venture:* The corporation or joint venture itself, and officers, directors, and controlling stockholders of *[Name of Bidder]* are not related by consanguinity or affinity up to the third civil degree to the Head of the Procuring Entity, Procurement Agent (if engaged), End-User or Implementing Unit, project consultants, head of the Project Management Office, or the members of the Bids and Awards Committee (BAC), the Technical Working Group, and the BAC Secretariat;
 - *If individual consultant not registered under a sole proprietorship, in case of Consulting Services:* The individual consultant and its spouse are not related by consanguinity or affinity up to the third civil degree to the Head of the Procuring Entity, Procurement Agent (if engaged), End-User or Implementing Unit, project consultants, head of the Project Management Office, or the members of the Bids and Awards Committee (BAC), the Technical Working Group, and the BAC Secretariat;
- 7) It is understood that failure to faithfully disclose its relationship with the HoPE, members of the BAC, the TWG, and the BAC Secretariat, the head of the PMO or the end-user unit or implementing unit, and the project consultants of the Procuring Entity, or of the procurement agent by consanguinity or affinity up to the third civil degree, as well as its submission of beneficial ownership information containing false entries shall be subject to blacklisting under Section 100 of the IRR of RA No. 12009, without prejudice to criminal and civil liabilities under applicable laws, including their accessory penalties, if any.

Select one, delete the rest:

- *In case of corporations: [Name of Bidder]* declares its beneficial ownership information consistent with its updated General Information Sheet or Beneficial Ownership Declaration Form or any other document duly submitted to the SEC and has maintained a valid and updated file therein in compliance with Sections 20.2.9.1, 81, and 82 of the IRR of Republic Act (RA) No. 12009.
 - *In case of Foreign Bidders: [Name of Bidder]* submitted an appropriate equivalent document in English issued by the country of the bidder concerned in accordance with Section 20.2.9.2 of the IRR of RA No. 12009.
- 8) *[Name of Bidder]* complies with existing labor laws and standards; and
- 9) *[Name of Bidder]* is aware of and has undertaken the following responsibilities as a Bidder:
- a) Carefully examine all of the Bidding Documents;
 - b) Acknowledge all conditions, local or otherwise, affecting the implementation of the Contract;
 - c) Made an estimate of the facilities available and needed for the contract to be bid, if any; and
 - d) Inquire or secure Supplemental Bid Bulletin(s) issued for the *[Project Title]*.
- 10) *[Name of Bidder]* did not give or pay directly or indirectly, any commission, amount, fee, or any form of consideration, pecuniary or otherwise, to any person or official, personnel or representative of the government in relation to any procurement project or activity.
- 11) In case advance payment was made or given to *[Name of Bidder]*, failure to perform or deliver any of the obligations and undertakings in the contract shall be sufficient grounds to constitute criminal liability under existing laws.

IN WITNESS WHEREOF, I have hereunto set my hand this ___ day of ___, 20__ at _____, Philippines.

Duly authorized to sign the Bid for and behalf of:

[Insert Bidder's Name]

[Affiant's Signature over Printed Name]

[Position/Designation]

[Date]

JURAT

SUBSCRIBED AND SWORN to before me this _____ day of *[month]* *[year]* at *[place of execution]*, Philippines. Affiant/s is/are personally known to me and was/were identified by me through competent evidence of identity as defined in the 2004 Rules on Notarial Practice (A.M. No. 02-8-13-SC). Affiant/s exhibited to me

his/her *[insert type of government identification card used]*, with his/her photograph and signature appearing thereon, with no. _____.

WITNESS MY HAND AND SEAL this ____ day of *[month]* *[year]*.

NAME OF NOTARY PUBLIC

Notarial Commission No. _____

Notary Public for _____ until _____

Roll of Attorneys No. _____

PTR No. __, *[date issued]*, *[place issued]*

IBP No. __, *[date issued]*, *[place issued]*

Doc. No. _____

Page No. _____

Book No. _____

Series of _____.

Bid Securing Declaration Form

*[The duly accomplished form shall be submitted with the Bid
if bidder opts to provide this type of bid security]*

REPUBLIC OF THE PHILIPPINES)
CITY/MUNICIPALITY OF _____) S.S.

BID SECURING DECLARATION

Project Identification No.: [Number]

To: *ENGR. JOSEPH V. ASCUTIA*
Acting Governor
PLGU-Camarines Norte

I/We, the undersigned, declare that:

- 1) I/We understand that, according to your conditions, bids must be supported by a Bid Security, which may be in the form of a Bid Securing Declaration;
- 2) I/We accept that:
 - a) I/We shall enter into contract with the Procuring Entity and furnish the required performance security within ten (10) calendar days as indicated in the Bidding Documents, from receipt of the Notice of Award;
 - b) I/we will be automatically disqualified from bidding for any procurement contract with any Procuring Entity upon receipt of your Blacklisting Order; and
 - c) I/We will pay the applicable fine within fifteen (15) days from receipt of the written demand by the Procuring Entity for the commission of acts resulting to the enforcement of the Bid Securing Declaration under Sections 52.2 (a), 63.2, 69.1 and 100, except 100.3 (c), of the IRR of RA No. 12009; without prejudice to other legal action the government may undertake;

	<i>Applicable Fine</i>
a) in the case of a single bidder	<ol style="list-style-type: none">i) two percent (2%) of the Approved Budget for the Contract (ABC); orii) the difference between the evaluated bid price and the ABC whichever is higher
b) in the case of multiple bidders	<ol style="list-style-type: none">i) two percent (2%) of the ABC; orii) the difference between the evaluated bid prices with the bidder with Lowest Calculated/Highest Rated Bid and the bidder with the next Lowest

	Calculated/Highest Rated Bid, and so on whichever is higher
c) in case of violations committed prior to the opening of the financial envelope	i) a fixed amount of two percent of the ABC,

- 3) I/We understand that this Bid Securing Declaration shall cease to be valid on the following circumstances:
- a) Upon expiration of the bid validity period, or any extension thereof pursuant to your request;
 - b) I am/we are declared ineligible or post-disqualified upon receipt of your notice to such effect, and (i) I/we failed to timely file a request for reconsideration or (ii) I/we filed a waiver to avail of said right;
 - c) I am/we are declared the bidder with the *[Insert Award Criterion¹]* and I/we have furnished the performance security and signed the Contract.

IN WITNESS WHEREOF, I/We have hereunto set my/our hand/s this ____ day of *[month]* *[year]* at *[place of execution]*.

Duly authorized to sign the Bid for and behalf of:

[Insert Bidder's Name]

[Signature over Printed Name]

[Position/Designation]

[Date]

JURAT

SUBSCRIBED AND SWORN to before me this ____ day of [month] [year] at [place of execution], Philippines. Affiant/s is/are personally known to me and was/were identified by me through competent evidence of identity as defined in the 2004 Rules on Notarial Practice (A.M. No. 02-8-13-SC). Affiant/s exhibited to me his/her [insert type of government identification card used], with his/her photograph and signature appearing thereon, with no. _____.

WITNESS MY HAND AND SEAL this ____ day of [month] [year].

NAME OF NOTARY PUBLIC

Notarial Commission No. _____

Notary Public for _____ until _____

Roll of Attorneys No. _____

PTR No. __, [date issued], [place issued]

IBP No. __, [date issued], [place issued]

Doc. No. _____

Page No. _____

Book No. _____

Series of _____

AFFIDAVIT OF SITE INSPECTION

I, (Representative of the Bidder) , of legal age, (civil status) , Filipino and residing at (Address of the Representative) , under oath, hereby depose and say:

1. That I am the (Position in the Bidder) of the (Name of the Bidder) , with office at (Address of the Bidder) ;
2. That I have inspected the site for (Name of the Contract) , located at (location of the Contract) ;
3. That I am making this statement as part of the requirement for the Technical Proposal of the (Name of the Bidder) for (Name of the Contract) .

IN FAITH WHEREOF, I hereby affix my signature this day of , 20 at , Philippines.

AFFIANT

Witness:

SUBSCRIBED AND SWORN TO before me this , day of 20 , affiant exhibiting to me his/her Community Tax Certificate No. issued on at , Philippines.

(Notary Public)

Until _____
PTR No. _____
Date _____
Place _____
TIN _____

Doc. No. _____
Page No. _____
Book No. _____
Series of _____

Bids and Awards Committee
Provincial Government of Camarines Norte
Provincial Capitol Building
Daet, Camarines Norte

AFFIDAVIT OF AVAILABILITY OF KEY PERSONNEL AND EQUIPMENT

I, _____ of legal age, Filipino, married/single/widow, and, a resident of _____, owner/proprietor of _____ after having been duly sworn to in accordance with law, depose and declare;

1. That I/we have engage and contracted the service of Engr. _____ (herein called the Resident/Project Engineer), a Registered Civil Engineer with Professional License No. _____ issued on _____ and who has paid his Professional Tax for the Current Year _____;
2. That the said Engineer shall be appointed and designated as our Resident/Project Engineer to personally manage and supervise the construction.
3. That the said Engineer shall employ the best care, skill and ability in supervising the project in accordance with the Contract Agreement, contract plan, and other provisions embodied in the proposed contract;
4. That the said Engineer shall be personally present at the jobsite to supervise all the phase of the construction work at all time;
5. That all other key personnel are available for the project;
6. That equipment needed for the project, are likewise available;
7. That any willful violation on my/our part of the herein condition may prejudice my/our standing as a reliable contractor in future biddings in your office.

IN WITNESS WHEREOF, I have here unto set my hands this _____ day of _____, 20____ at _____, Philippines.

Affiant's Printed Name and Signature

WITNESSES:

SUBSCRIBED AND SWORN to before me this _____ day of _____, 20____ affiant exhibiting to me his/her Resident Certificate No.: _____ issued _____ at _____.

Notary Public

Doc No.: _____
Page No.: _____
Book No.: _____
Series of: _____

Bids and Awards Committee
 Provincial Government of Camarines Norte
 Provincial Capitol Building
 Daet, Camarines Norte

KEY PERSONNEL'S CERTIFICATE OF EMPLOYMENT

_____ *Date*

Dear Sir / Madame:

I am (Name of Nominee) a Licensed Engineer with Professional License No. _____ issued on (date of issuance) at (place of issuance) .

I hereby certify that (Name of Bidder) has engaged my services as (Designation) for (Name of the Contract) , if awarded to it.

As (Designation) , I supervised the following completed projects similar to the contract under bidding:

<u>NAME OF PROJECT</u>	<u>OWNER</u>	<u>COST</u>	<u>DATE COMPLETED</u>
_____	_____	_____	_____
_____	_____	_____	_____
_____	_____	_____	_____
_____	_____	_____	_____

At present, I am supervising the following projects:

<u>NAME OF PROJECT</u>	<u>OWNER</u>	<u>COST</u>	<u>DATE COMPLETED</u>
_____	_____	_____	_____
_____	_____	_____	_____
_____	_____	_____	_____
_____	_____	_____	_____

In case of my separation for any reason whatsoever from the above-mentioned Contractor, I shall notify the (Name of the Procuring Entity) at least twenty one (21) days before the effective date of my separation.

As (Designation), I know I will have to stay in the job site all the time to supervise and manage the Contract works to the best of my ability, and aware that I am authorized to handle only one (1) contract at a time.

I do not allow the use of my name for the purpose of enabling the above-mentioned Contractor to qualify for the Contract without any firm commitment on my part to assume the post of (Designation) therefore, if the contract is awarded to him since I understand that to do so will be a sufficient ground for my disqualification as (Designation) in any future (Name of the Procuring Entity) bidding or employment with any Contractor doing business with the (Name of the Procuring Entity).

(Signature of Engineer)

WITNESSES:

DRY SEAL

Republic of the Philippines)
_____) S.S.

SUBSCRIBED AND SWORN TO before me this _____ day of _____ 20__ affiant exhibiting to me his Residence Certificate No. _____ issued on _____ at _____.

NOTARY PUBLIC
PTR No.: _____
Issued at: _____
Issued on: _____
Until 31 December 20____

Doc. No.: _____;
Page No. : _____;
Book No.: _____;
Series of _____;

Section X. Checklist of Technical and Financial Documents

Checklist of Technical and Financial Documents

Note: This shall serve as a guide in the preparation of the bid submission. Any inconsistencies between the Bid Data Sheet (BDS) and this Checklist, the BDS shall prevail.

I. TECHNICAL COMPONENT ENVELOPE

Class “A” Documents

Legal Documents

- (a) Valid and updated PhilGEPS Registration Certificate (Platinum Membership) (all pages) (In compliance with Section 20.2.9.1 of IRR of RA No. 12009); and

Technical Documents

- (b) Statement of the prospective bidder of all its ongoing government and private contracts, including contracts awarded but not yet started, if any, whether similar or not similar in nature and complexity to the contract to be bid; **and**
- (c) Statement of the bidder’s Single Largest Completed Contract (SLCC) similar to the contract to be bid, except under conditions provided under the rules; (This statement shall be supported by contracts, owner’s final acceptance or equivalent document, and CPES rating sheets, if applicable. These supporting documents shall be numbered and tabbed in the same sequence as the list of contracts appears in this statement.); **and**
- Special PCAB License in case of Joint Ventures/Consortium; **and** registration for the type and cost of the contract to be bid (GPPB Resolution No.15-2021); **and**
- (d) Original copy of Bid Security. If in the form of a Surety Bond, submit also a certification issued by the Insurance Commission;
Or Original copy of Notarized Bid Securing Declaration; **and**
- (e) Project Requirements, which shall include the following:
 - a. Organizational chart for the contract to be bid;
 - b. List of contractor’s key personnel (*e.g.*, Project Manager, Project Engineers, Materials Engineers, and Foremen), to be assigned to the contract to be bid, with their complete qualification and experience data;
 - c. List of contractor’s major equipment units, which are owned, leased, under purchase agreements, supported by proof of ownership or certification of availability of equipment from the equipment lessor/vendor for the duration of the project, as the case may be
 - d. Key Personnel’s Certificate of Employment (notarized)
 - e. Original duly signed Omnibus Sworn Statement (OSS);

and if applicable, Original Notarized Secretary's Certificate in case of a corporation, partnership, or cooperative; or Original Special Power of Attorney of all members of the joint venture giving full power and authority to its officer to sign the OSS and do acts to represent the Bidder.

Financial Documents

- (f) The prospective bidder's audited financial statements, showing, among others, the prospective bidder's total and current assets and liabilities, stamped "received" by the BIR or its duly accredited and authorized institutions, for the preceding calendar year which should not be earlier than two (2) years from the date of bid submission
- (g) The prospective bidder's computation of Net Financial Contracting Capacity (NFCC).

Class "B" Documents

- (h) If applicable, duly signed joint venture agreement (JVA) in accordance with RA No. 4566 and its IRR in case the joint venture is already in existence;

II. FINANCIAL COMPONENT ENVELOPE

- (i) Original of duly signed and accomplished Financial Bid Form; **and**

Other documentary requirements under RA No. 12009

- (j) Original of duly signed Bid Prices in the Bill of Quantities; **and**
- (k) Duly accomplished Detailed Estimates Form, including a summary sheet indicating the unit prices of construction materials, Dayworks Schedule, labor rates, and equipment rentals used in coming up with the Bid; **and**
- (l) Cash Flow by Quarter.

DAYWORKS SCHEDULE - LABOR

Project Name: Rebidding for the Design and Build of _____

NO	TYPE OF LABOR	UNIT	RATE
L01	Foreman	Hour	
L03	Heavy Equipment Operator	Hour	
L06	Driver	Hour	
L07	Skilled Laborer	Hour	
L10	Other (specify)	Hour	

Uncontrolled when printed and emailed

DAYWORKS SCHEDULE - MATERIALS

Project Name: Rebidding for the Design and Build of _____

NO	TYPE OF MATERIALS/SPECIFICATION	UNIT	RATE
M01	Aggregate Subbase Course	Cu.M.	
M02	Portland Cement	Bag	
M22	Others (Specify)		

Uncontrolled when printed and emailed

2. **For Labor Component** – the cost of labor shall include the following:
 - 2.1. Salaries and wages, as authorized by the Department of Labor and Employment (DOLE), issued by the DPWH through a memorandum.
 - 2.2. Fringe benefits, such as vacation and sick leaves, benefits under the Workmen’s Compensation Act, GSIS and/or SSS contributions, allowances, 13th month pay, bonuses, etc.
3. **For Equipment Component** – the equipment expenses shall comply with the following:
 - 3.1. Rental rates of equipment shall be based on the current Association of Carriers and Equipment Lessors (ACEL) Equipment Guidebook approved for use by the DPWH. Rental rates of equipment not indicated in the ACEL Equipment Guidebook shall be taken from the rental rates prepared by the Bureau of Equipment (BOE). For simplicity in computation, the operated rental rates are preferred over the bare rental rates as the former includes operator’s wages, fringe benefits, fuel, oil, lubricants, and equipment maintenance. The make, model, and capacity of the equipment to be utilized should be indicated in the DUPA.
 - 3.2. Mobilization/Demobilization pay item shall be calculated based on the equipment requirements of the project stipulated in the proposal and contract booklet. The cost of mobilization and demobilization shall not exceed 1% of the Estimated Direct Cost (EDC) of all programmed pay items that are civil works in nature, including those pay items under Facilities for the Engineers and Other General Requirements that are civil work in nature. However, in exceptional circumstances where the mobilization and demobilization cost exceed the prescribed 1% threshold, the DUPA reflecting the actual computed mobilization and demobilization costs shall be approved, duly signed, by the approving authority, in accordance with the latest limits of delegated authority governing the approval of POW and ABC. A copy of the approved DUPA for Mobilization/Demobilization, along with the corresponding POW and ABC, must be submitted to the BOC within fifteen (15) calendar days from the date of approval.
 - 3.3. Permits and Clearances pay item shall include the cost of securing MMDA permit, LGU permits, Bureau of Fire Protection Clearance, and other government fees.

B. The **Indirect Cost** shall consist of the following:

1. **Overhead, Contingencies, and Miscellaneous (OCM) Expenses:**
 - 1.1. Overhead Expense shall be 7% to 11% of the EDC, and shall include the following:
 - 1.1.1. Engineering and administrative supervision
 - 1.1.2. Transportation allowances



- 1.1.3. Office expenses (e.g., for the rental of office and quarters, service vehicle, office equipment and supplies, power and water consumption, communication and maintenance)
- 1.1.4. Premium on Contractor’s All Risk Insurance (CARI)
- 1.1.5. Financing cost such as:
 - a. Premium on Bid Security
 - b. Premium on Performance Security
 - c. Premium on Surety for Advance Payment
 - d. Premium on Warranty Security (one year)
- 1.2. Contingencies shall be 0.5% to 3% of the EDC, and shall include expenses for monthly/weekly meetings, coordination meetings with other stakeholders, billboards (excluding Project Billboard/Signboard required by the DPWH and other Government Agencies such as: COA, DENR, etc., which shall be programmed under Part B - Other General Requirements), stages during the groundbreaking and inauguration ceremonies, and unforeseen/other events relative thereto.
- 1.3. Miscellaneous Expenses shall be 0.5% to 1% of the EDC, and shall include laboratory tests for quality control and plan preparation.

2. **Contractor’s Profit (CP)** shall be 8% of the EDC for projects with EDC of above PhP 5 Million and 10% for projects with EDC of PhP 5 Million and below.

For ease of calculation, the mark-up percentages for OCM and CP, based on the EDC, shall be specified in the following table.

Estimated Direct Cost (EDC)	OCM (% of EDC)	CP (% of EDC)	Total (% of EDC)
Up to PhP 5 Million	15	10	25
Above PhP 5 Million to PhP 50 Million	12	8	20
Above PhP 50 Million to PhP 150 Million	10	8	18
Above PhP 150 Million	8	8	16

The applicability of OCM and CP for pay items under Facilities for the Engineer (Part A) and Other General Requirements (Part B) are set forth in **Annexes A and B**.

3. **Value Added Tax (VAT) Component** – shall be a percentage of the sum of the EDC, OCM, and CP. The applicable rate shall be based on the latest guidelines issued by the DPWH Finance Service, in adherence to the provisions of the National Internal Revenue Code and its amendments, wherein the



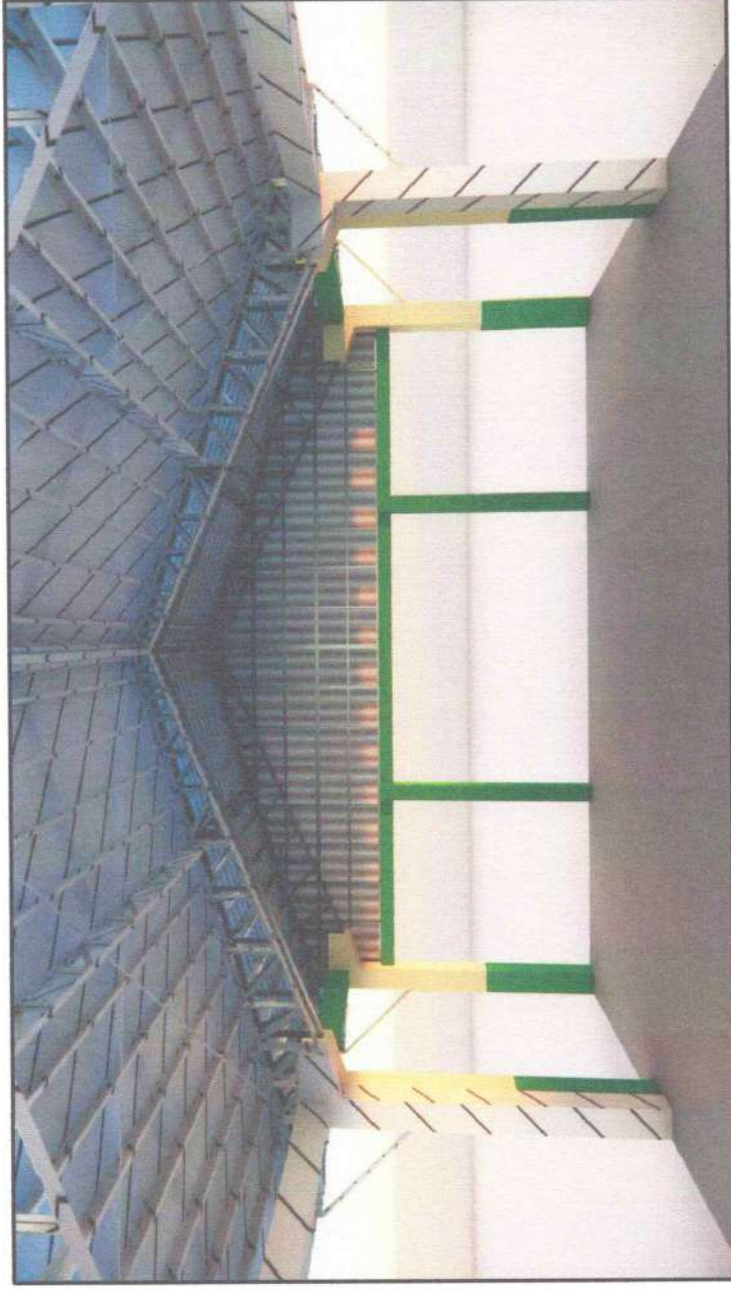

PER S P E C T I V E
SCALE

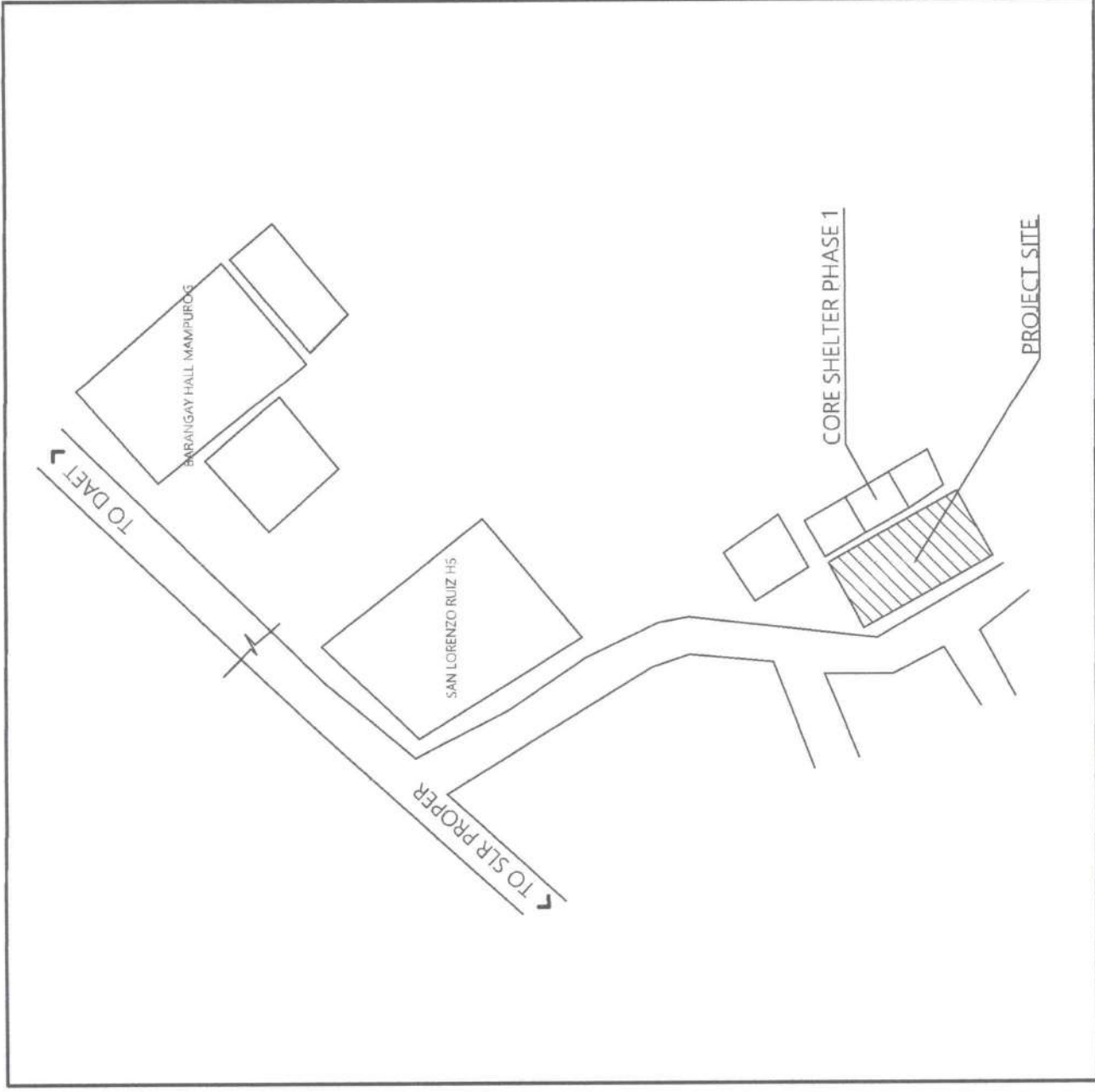

LOCATION PLAN
SCALE

PROVINCE OF CAMARINES NORTE OFFICE OF THE PROVINCIAL ENGINEER REPUBLIC OF THE PHILIPPINES PROVINCE OF CAMARINES NORTE	PROJECT TITLE/LOCATION: EXTENSION OF COVERED COURT AND FLOORING P-4, BRGY. MAMPUROS, SAN LORENZO RUIZ, CAMARINES NORTE	PREPARED BY: ANTONMAR R. GAN DRAFTER III CADD BY: ENGR. MARC LYLMYR D. NAGERA	CHECKED AND SUBMITTED BY: SAHVEE T. YANO CHIEF-PLANNING DIVISION	REVIEWED BY: BELLA B. ORIOLA ACTING ASSISTANT PROVINCIAL ENGINEER	RECOMMENDING APPROVAL: JOHN MARVIL S. TOBIAS PROVINCIAL ENGINEER	APPROVED BY: HON. JOSEPH V. ASCUTTIA ACTING GOVERNOR	SHEET NUMBER 1 of 8
	Oct. 06, 2025 REV: Oct. 13, 2025						

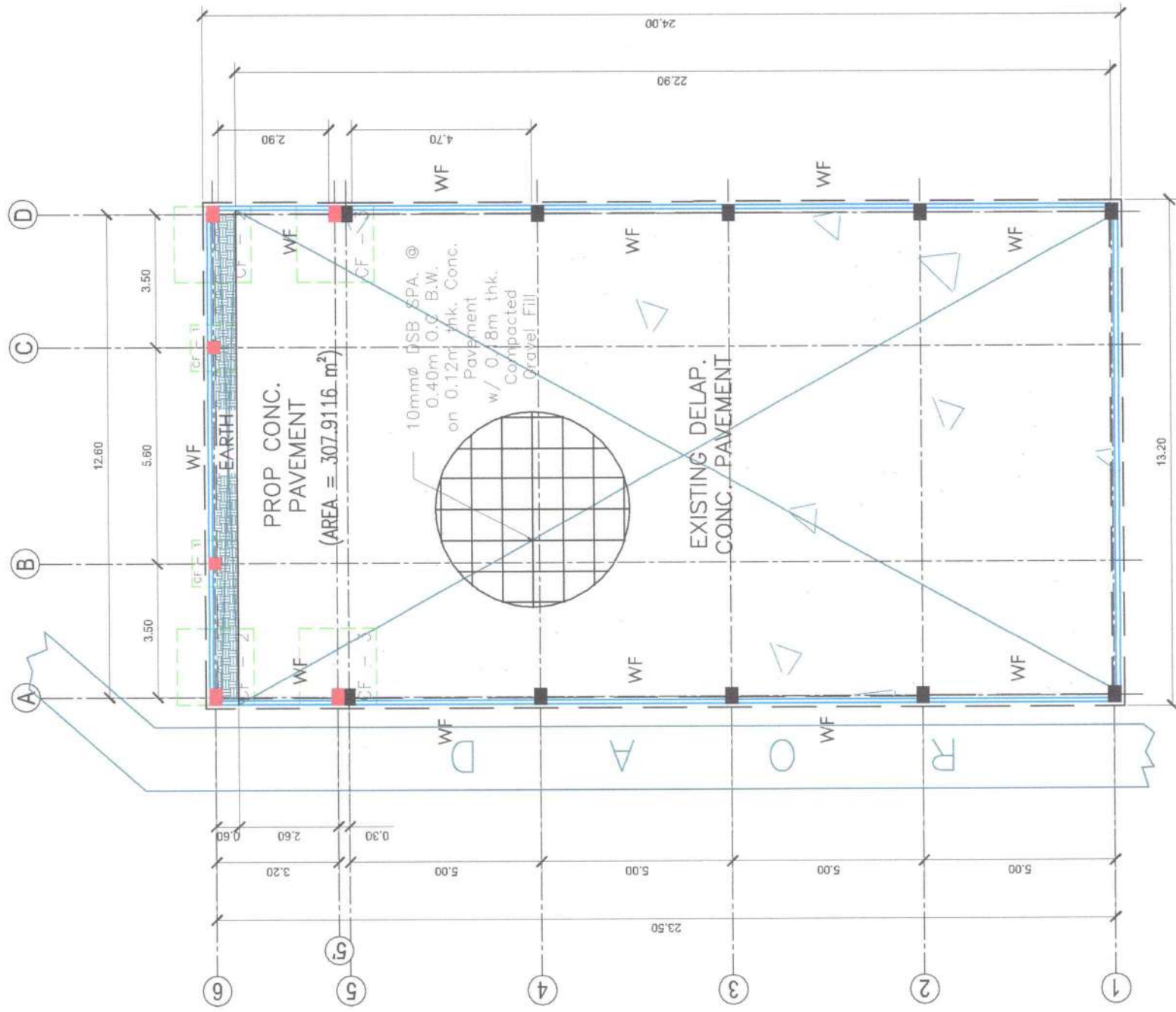

FLOOR PLAN / FOUNDATION PLAN
SCALE 1 : 150M

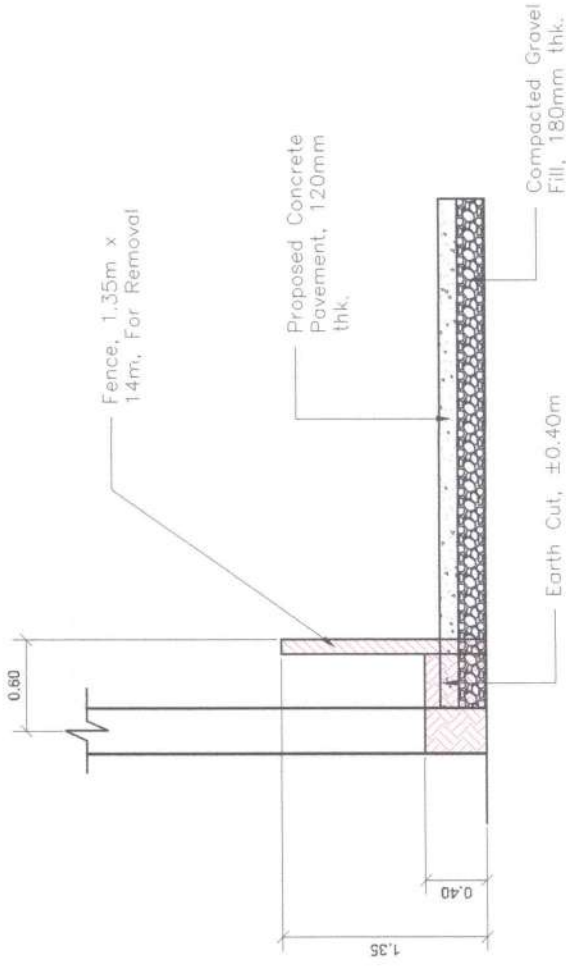

SITE PREPARATION AND EARTHWORKS
SCALE 1 : 50M

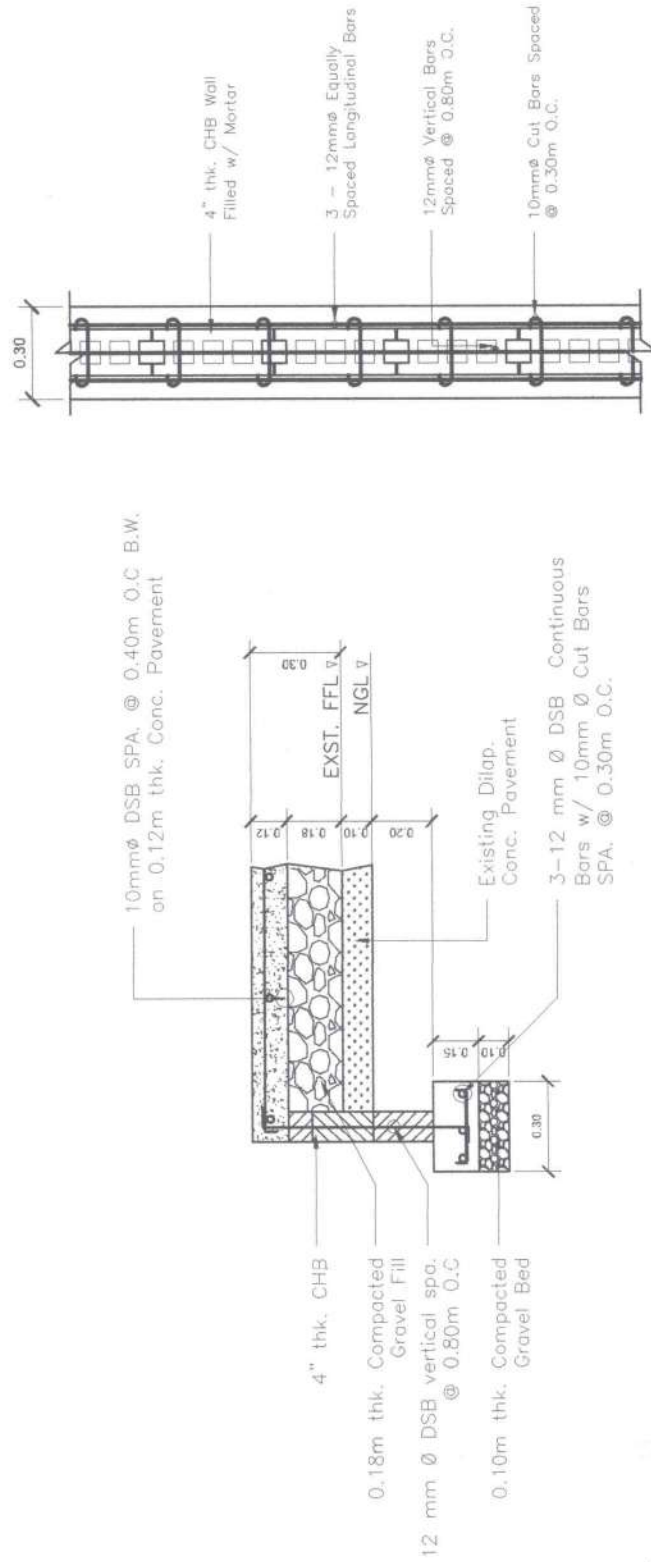

DETAIL OF CONCRETE PAVEMENT & WALL FOOTING
SCALE 1 : 25M

	PROJECT TITLE/LOCATION: EXTENSION OF COVERED COURT AND FLOORING P-4, BRGY. MAMPURONG, CAMARINES NORTE SAN LORENZO RUIZ, CAMARINES NORTE	PREPARED BY: ANTONIO BAGAN DR/PTSMAN/III CADD BY: ENGR. MACK TOBY D. MANLAPAZ	CHECKED AND SUBMITTED BY: SAM LEE T. YANTO CHIEF-PLANNING DIVISION	REVIEWED BY: BELLA B. ORIOLA ACTING ASSISTANT PROVINCIAL ENGINEER	RECOMMENDING APPROVAL: JOHN MARVIL S. TOBIAS PROVINCIAL ENGINEER	APPROVED BY: HON. JOSEPH V. ASCUTION ACTING GOVERNOR	SHEET NUMBER 2 / 8 REV: Oct. 13, 2025
	Oct. 06, 2025						

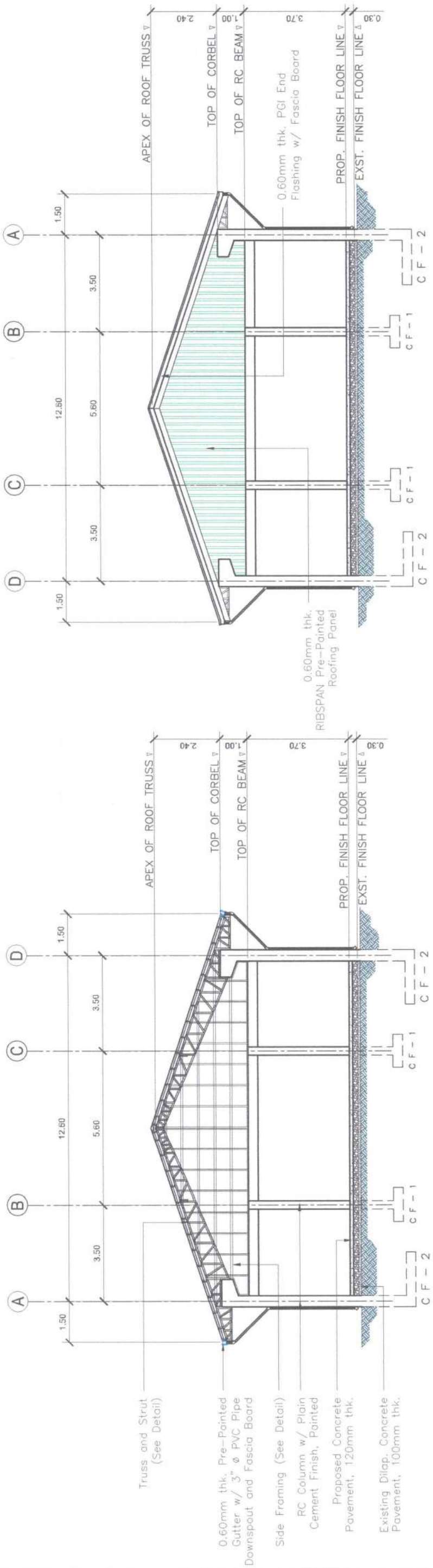

FRONT ELEVATION / SECTION THRU - X
SCALE 1 : 150M

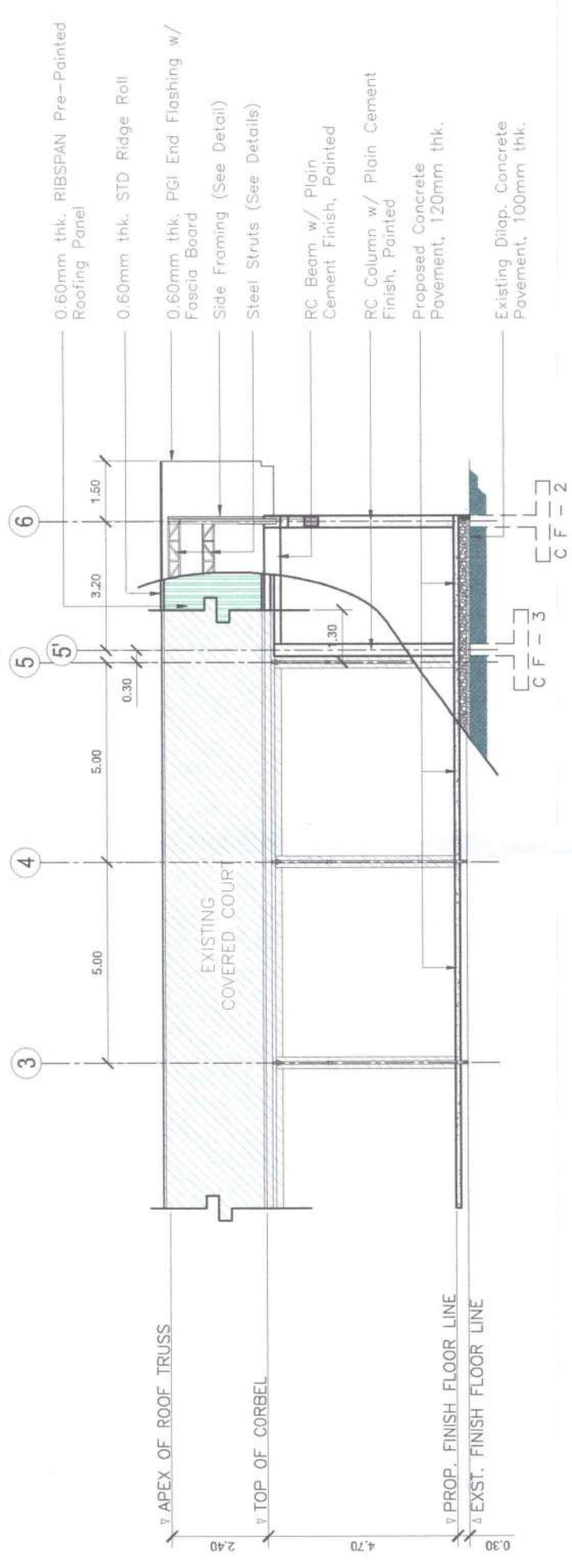

REAR ELEVATION
SCALE 1 : 150M

SIDE ELEVATION / SECTION THRU - Y
SCALE 1 : 150M

	PROJECT TITLE/LOCATION: EXTENSION OF COVERED COURT AND FLOORING P-4, BRGY. MAMPUROG, SAN LORENZO RUIZ, CAMARINES NORTE	PREPARED BY: ANTONIO R. GAN <small>DEPUTY MANIL</small> CADD BY: ENGR. MARC LYLLMYR D. NIGERA	CHECKED AND SUBMITTED BY: SAHLEE T. YANO CHIEF-PLANNING DIVISION	REVIEWED BY: BELLA B. ORIOLA ACTING ASSISTANT PROVINCIAL ENGINEER	RECOMMENDING APPROVAL: JOHN MARIL S. TOBIAS PROVINCIAL ENGINEER	APPROVED BY: HON. JOSEPH V. ASCUTIA ACTING GOVERNOR	SHEET NUMBER 3 of 8
	REPUBLIC OF THE PHILIPPINES PROVINCE OF CAMARINES NORTE OFFICE OF THE PROVINCIAL ENGINEER						

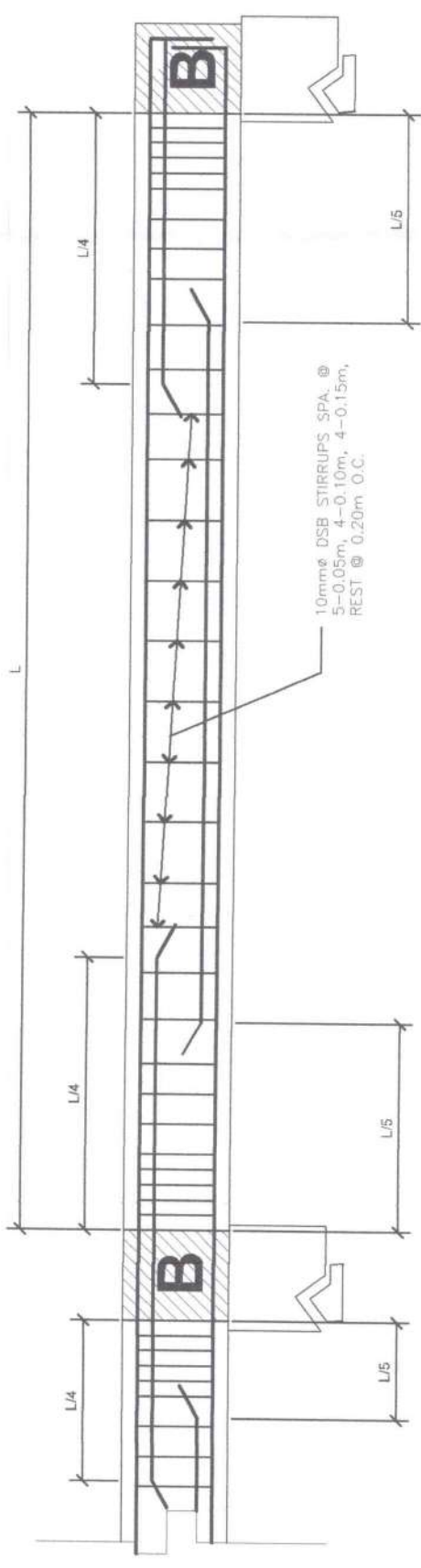

DETAIL OF BEAM
SCALE

MARK	DIMENSION	REINFORCEMENT	
		⊙SUPPORT	⊙MIDSPAN
RB1	300mm x 400mm		
RB2	250mm x 350mm		

SCHEDULE OF BEAM
SCALE

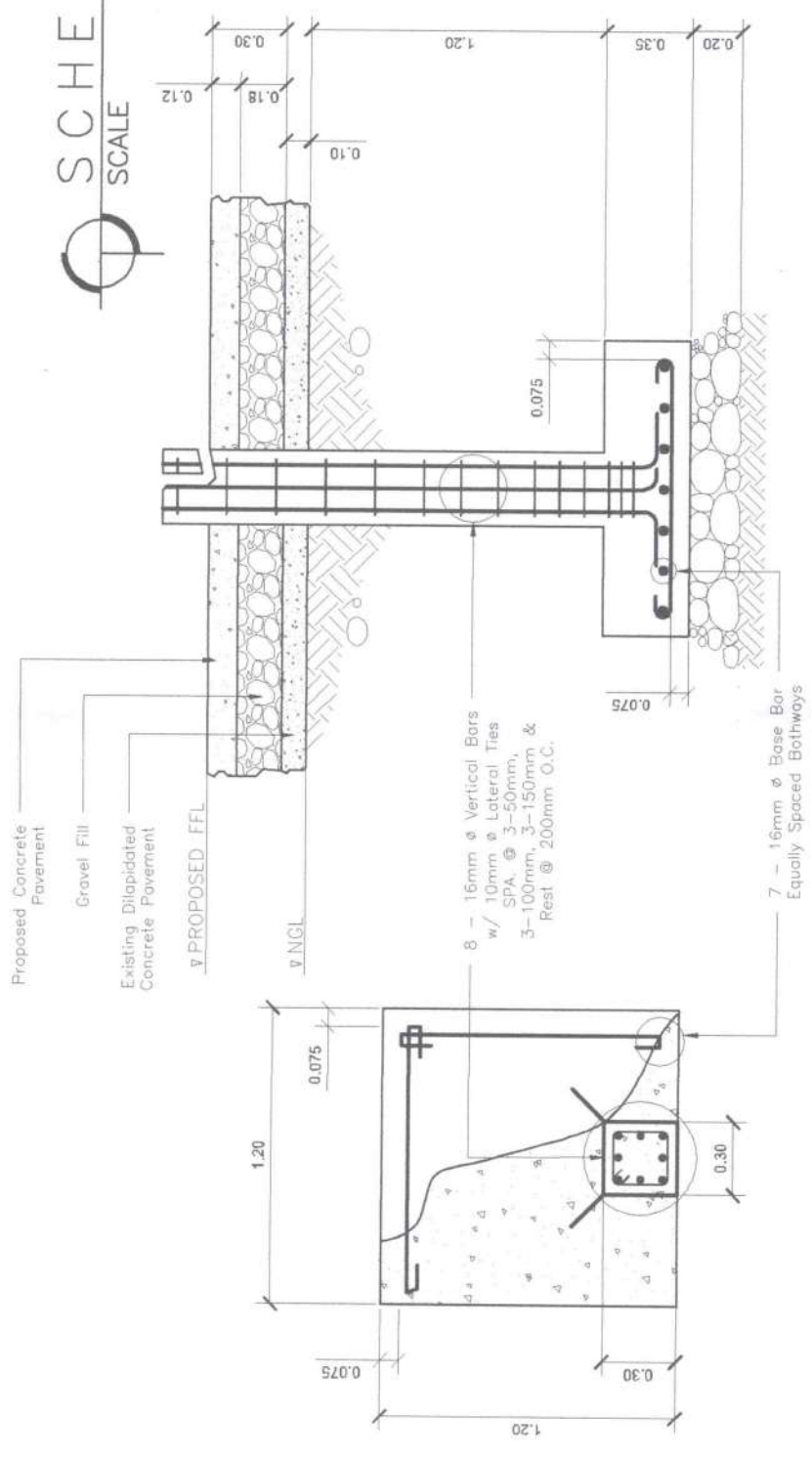

PLAN VIEW SECTION VIEW

DETAIL OF COLUMN FOOTING (CF - 1)
SCALE 1 : 30M

	PROJECT TITLE/LOCATION: EXTENSION OF COVERED COURT AND FLOORING P-4, BRGY. MAMPUROG, SAN LORENZO RUIZ, CAMARINES NORTE	PREPARED BY: ANTONIO R. GAN DRAFTER III CADD BY: ENGR. MARC LYLYN D. NAGERA	CHECKED AND SUBMITTED BY: SAHLEE T. YANTO CHIEF-PLANNING DIVISION	REVIEWED BY: BEILA B. ORIOLA ACTING ASSISTANT PROVINCIAL ENGINEER	RECOMMENDING APPROVAL: JOHN MARK S. TOBIAS PROVINCIAL ENGINEER	APPROVED BY: HON. JOSEPH V. ASCUTIA ACTING GOVERNOR	SHEET NUMBER 5 of 8 REV: Oct. 13, 2025
	REPUBLIC OF THE PHILIPPINES PROVINCE OF CAMARINES NORTE OFFICE OF THE PROVINCIAL ENGINEER	Oct. 06, 2025					

Notes:

- New column to be constructed adjacent to the existing covered court column.
- The proposed footing shall be placed on top of the existing footing with a 200 mm thick compacted gravel bed as leveling layer.
- Verify the existing footing's condition, depth, and capacity prior to construction.
- Provide adequate dowel or anchorage connection if required.

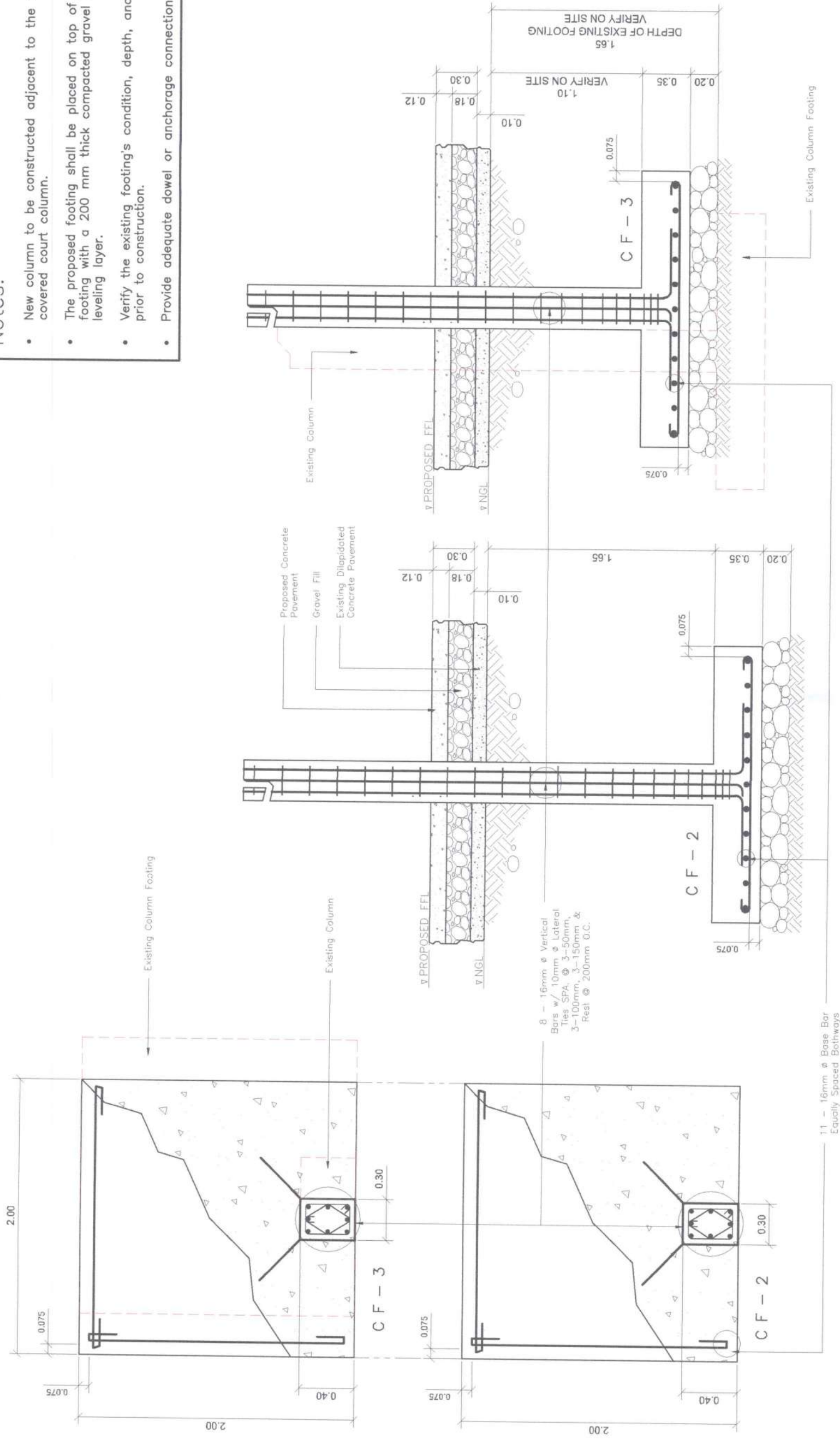

PLAN VIEW

SECTION VIEW

DETAIL OF COLUMN FOOTING (CF - 2 & CF - 3)
SCALE

 <p>REPUBLIC OF THE PHILIPPINES PROVINCE OF CAMARINES NORTE OFFICE OF THE PROVINCIAL ENGINEER</p>	<p>PROJECT TITLE/LOCATION: EXTENSION OF COVERED COURT AND FLOORING P-4, BRGY. MAMPURUG, SAN LORENZO RUIZ, CAMARINES NORTE</p>	<p>PREPARED BY: ANTONIO R. GAN DRAFTSMAN CADD BY: ENGR. MARC LYLIMYR D. NAGERA</p>	<p>CHECKED AND SUBMITTED BY: SAHLEE T. YANTO CHIEF-PLANNING DIVISION</p>	<p>REVIEWED BY: <i>[Signature]</i> BELLA B. ORIOLA ACTING ASSISTANT PROVINCIAL ENGINEER</p>	<p>RECOMMENDING APPROVAL: <i>[Signature]</i> JOHN-MARVIL S. TOBIAS PROVINCIAL ENGINEER</p>	<p>APPROVED BY: <i>[Signature]</i> HON. JOSEPH V. ASCUTIA ACTING GOVERNOR</p>	<p>SHEET NUMBER 6 of 8</p>
	<p>Oct. 06, 2025 REV: Oct. 13, 2025</p>						

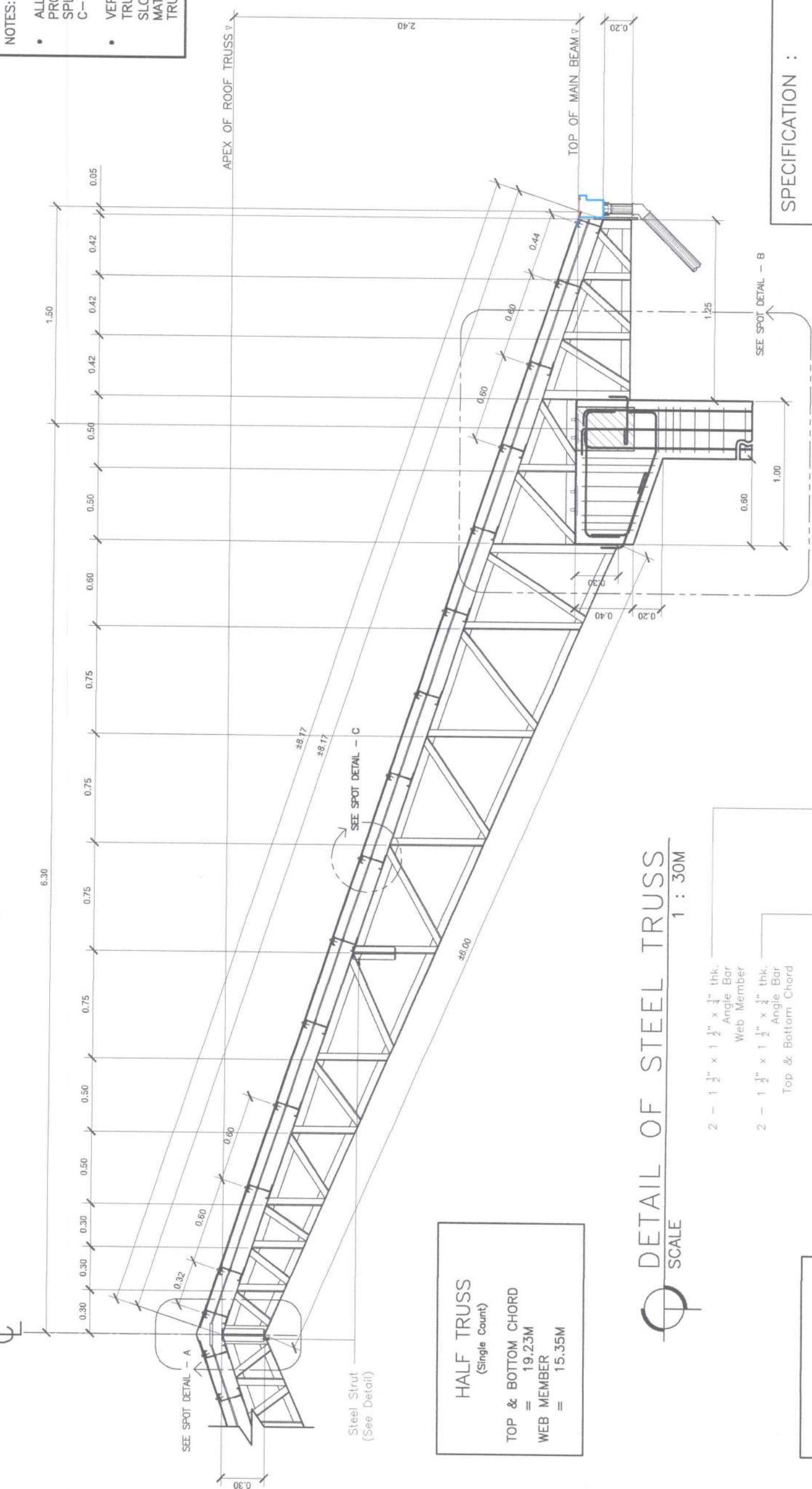

NOTES:

- ALL NEW C-PURLINS SHALL BE PROPERLY ALIGNED WITH AND SPICED TO THE EXISTING C-PURLINS.
- VERIFY ON SITE THAT THE FULL TRUSS CONDITIONS (GEOMETRY, SLOPE, AND SPACING) ARE MATCHED WITH THE EXISTING TRUSS.

SPECIFICATION :

- ALL STRUCTURAL STEEL SHALL BE A36 STEEL COLD FORMED.
- ALL STRUCTURAL BOLTS SHALL BE A325.
- ALL WELD SHALL BE FULL FILLET WELDS (SMAW PROCESS WITH E60XX ELECTRODES).

HALF TRUSS
(Single Count)
TOP & BOTTOM CHORD = 19.23M
WEB MEMBER = 15.35M

STEEL STRUT
(3.20M - Single Count)
TOP & BOTTOM CHORD = 6.40M
WEB MEMBER = 6.26M

DETAIL OF STEEL TRUSS
SCALE 1 : 30M

2 - 1 1/2" x 1 1/2" x 1/4" thk. Angle Bar Web Member
2 - 1 1/2" x 1 1/2" x 1/4" thk. Angle Bar Top & Bottom Chord

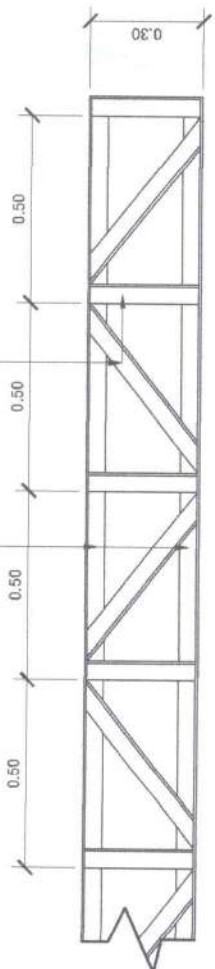

STEEL STRUT DETAIL
SCALE 1 : 20M

	PROJECT TITLE/LOCATION: EXTENSION OF COVERED COURT AND FLOORING P-4, BRGY. MAMPUROG, SAN LORENZO RUIZ, CAMARINES NORTE	PREPARED BY: ANTONIO R. GAN <small>DRAFTSMAN</small> CADD BY: ENGR. MARCELYN D. NAGERA	CHECKED AND SUBMITTED BY: SAHLEE T. YANTO CHIEF-PLANNING DIVISION	REVIEWED BY: BELJA B. ORIOLA ACTING ASSISTANT PROVINCIAL ENGINEER	RECOMMENDING APPROVAL: JOHN MARVEL S. TOBIAS PROVINCIAL ENGINEER	APPROVED BY: HON. JOSEPH V. ASCUITA ACTING GOVERNOR	SHEET NUMBER 7 8
	REPUBLIC OF THE PHILIPPINES PROVINCE OF CAMARINES NORTE OFFICE OF THE PROVINCIAL ENGINEER	Oct. 06, 2025	REV: Oct. 13, 2025				

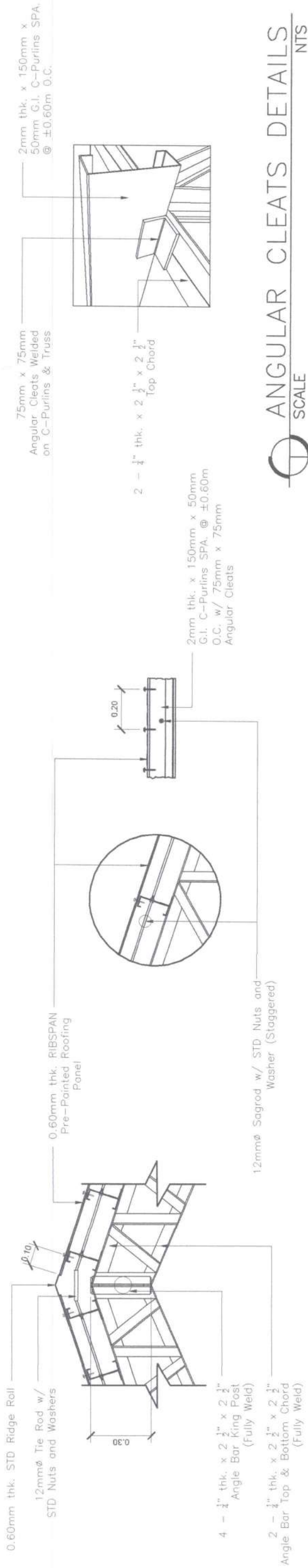

SPOT DETAIL - A 1 : 20M **SCALE**

ANGULAR CLEATS DETAILS NTS **SCALE**

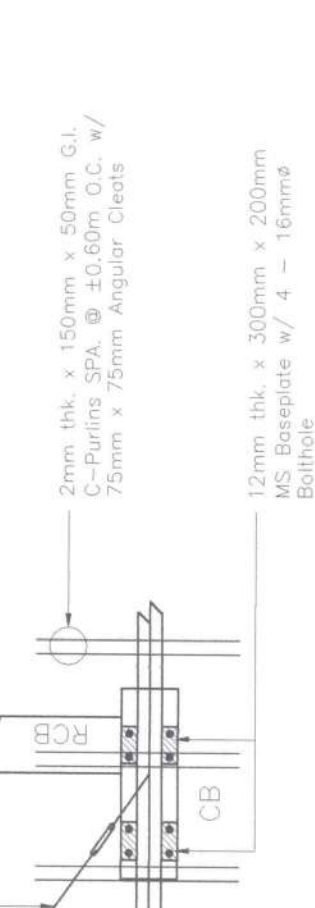

TYP. TRUSS ANCHORAGE DETAIL 1 : 40M **SCALE**

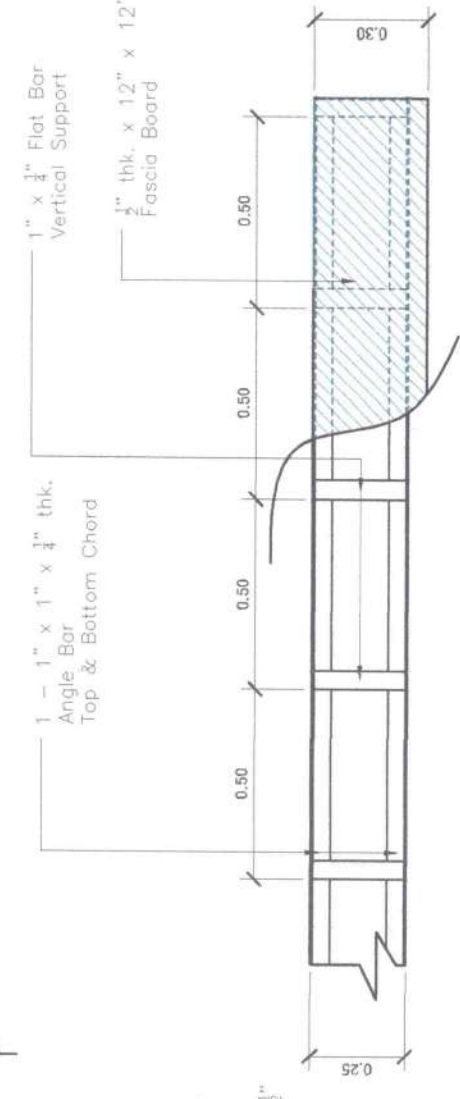

SPOT DETAIL - C 1 : 20M **SCALE**

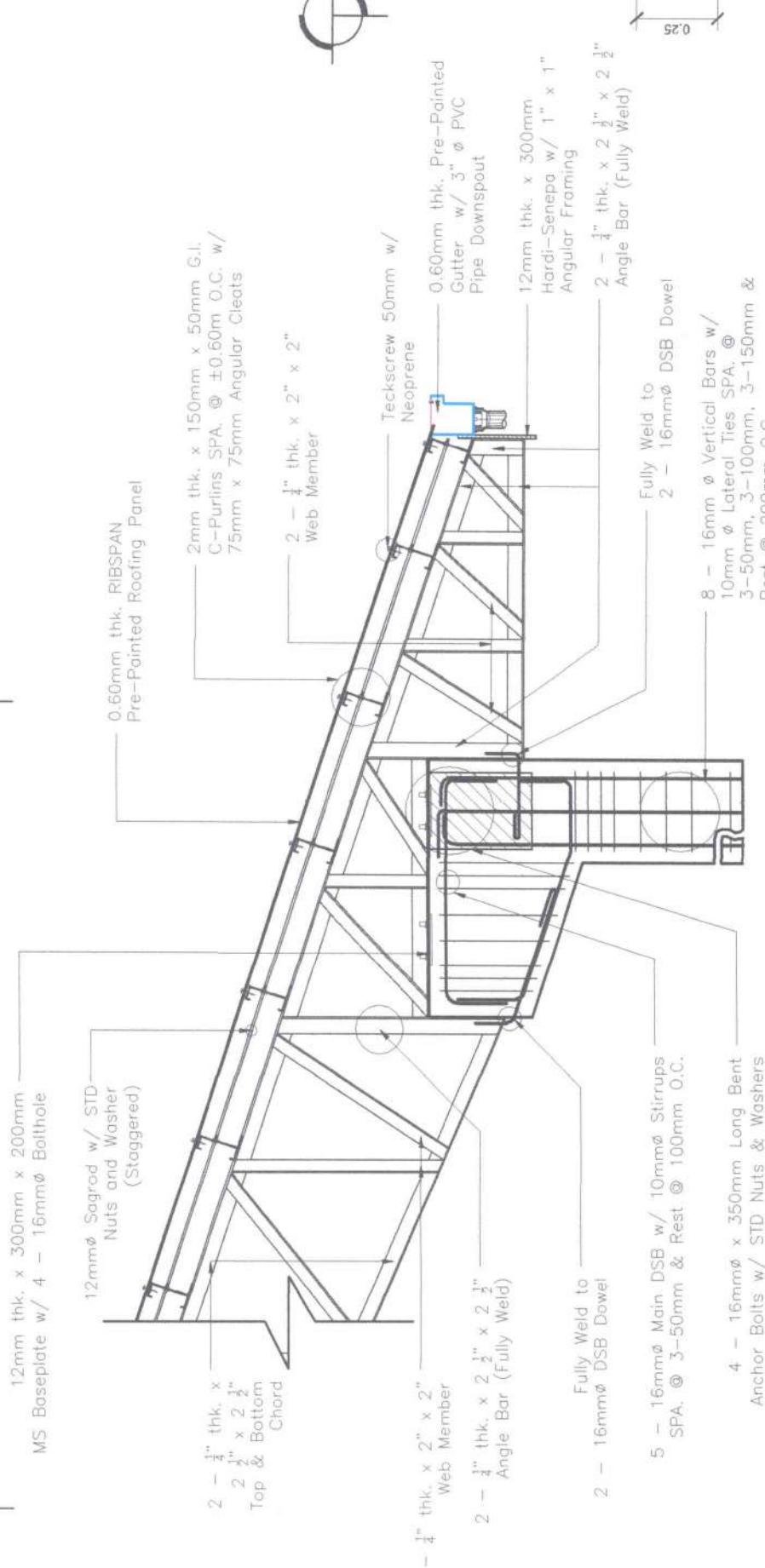

SPOT DETAIL - B 1 : 25M **SCALE**

DETAILS OF FASCIA FRAME 1 : 20M **SCALE**

	PROJECT TITLE/LOCATION: EXTENSION OF COVERED COURT AND FLOORING P-4, BRGY. MAMPUROG, SAN LORENZO RUIZ, CAMARINES NORTE	PREPARED BY: ANTONIO R. GAN DRAFTSMAN CADD BY: ENGR. MARC LYLIM D. NAGERA	CHECKED AND SUBMITTED BY: SAHLEE T. YANTO CHIEF PLANNING DIVISION	REVIEWED BY: BELLA B. ORIOLA ACTING ASSISTANT PROVINCIAL ENGINEER	RECOMMENDING APPROVAL: JOHN MARVIL S. TOBIAS PROVINCIAL ENGINEER	APPROVED BY: HON. JOSEPH V. ASCUTIA ACTING GOVERNOR	SHEET NUMBER 8 / 8
	REPUBLIC OF THE PHILIPPINES PROVINCE OF CAMARINES NORTE OFFICE OF THE PROVINCIAL ENGINEER	Oct. 06, 2025	REV: Oct. 13, 2025				